



**WINNER**<sup>®</sup>  
**FISHING TACKLE**



**CATALOGUE 2026**

**[WWW.WINNERFISHINGTACKLE.GR](http://WWW.WINNERFISHINGTACKLE.GR)**

## ΠΕΡΙΕΧΟΜΕΝΑ / CONTENTS

<b>1. ΚΑΛΑΜΙΑ / RODS</b>	<b>2 - 11</b>
<b>2. ΜΗΧΑΝΑΚΙΑ / REELS</b>	<b>11 - 12</b>
<b>3. ΘΗΚΕΣ ΚΑΛΑΜΙΩΝ / RODS BAGS</b>	<b>13</b>
<b>4. ΑΓΓΙΣΤΡΙΑ / HOOKS</b>	<b>14 - 18</b>
<b>5. ΣΤΡΙΦΤΑΡΙΑ, ΠΑΡΑΜΑΝΕΣ / SWIVELS, SNAPS</b>	<b>19 - 22</b>
<b>6. ΜΙΣΙΝΕΖΕΣ / DYNEMA</b>	<b>23 - 26</b>
<b>7. ΦΕΛΛΟΙ / FISHING FLOATS</b>	<b>27 - 31</b>
<b>8. ΤΣΑΠΑΡΙ / SABIKI</b>	<b>32 - 33</b>
<b>9. ΤΕΧΝΗΤΑ ΔΟΛΩΜΑΤΑ / PLASTIC LURES</b>	<b>34 - 52</b>
<b>10. ΑΞΕΣΟΥΑΡ / ACCESSORIES</b>	<b>53 - 71</b>
<b>11. ΔΟΛΩΜΑΤΑ / BAIT</b>	<b>72 - 73</b>
<b>12. ΑΠΟΧΕΣ / LANDING NETS</b>	<b>74 - 76</b>
<b>13. ΚΑΤΑΔΥΤΙΚΑ / DIVING</b>	<b>77 - 81</b>

# LIGHT JIGGING RODS

## LIGHT SHORE JIG



CODE	LENGTH OPEN m	PCS	LENGTH CLOSED cm	WEIGHT gr	ACTION gr	MATERIAL
21.34.270	2,70	2	139	180	5-30	CARBON IM 7

## TAI RUBBER



CODE	LENGTH OPEN m	PCS	LENGTH CLOSED cm	WEIGHT gr	ACTION gr	MATERIAL
21.28.205	2,05	2	152	145	40-120	CARBON IM 7 NANO CHEMICAL TECHNOLOGY

## ELPIS TAI RUBBER



CODE	LENGTH OPEN m	PCS	LENGTH CLOSED cm	WEIGHT gr	ACTION gr	MATERIAL
21.29.001	2,05	2	150	120	20-80	IM 7 GRAPHITE NANO CHEMICAL TECHNOLOGY
21.29.002	2,05	2	150	130	30-100	IM 7 GRAPHITE NANO CHEMICAL TECHNOLOGY

## LORD LRF 1



CODE	LENGTH OPEN m	PCS	LENGTH CLOSED cm	WEIGHT gr	ACTION gr	MATERIAL
21.37.001	2,40	2	125	120	0,5-10	CARBON IM 7 NANO CHEMICAL TECHNOLOGY
	FUJI GUIDES					

## LORD LRF 2



CODE	LENGTH OPEN m	PCS	LENGTH CLOSED cm	WEIGHT gr	ACTION gr	MATERIAL
21.37.002	2,40	2	125	135	3-20	CARBON IM 7 NANO CHEMICAL TECHNOLOGY
	FUJI GUIDES					

## EGING RODS

### SILA EGI



CODE	LENGTH OPEN m	PCS	LENGTH CLOSED cm	WEIGHT gr	PE	GUIDE TYPE	REEL SEAT TYPE	ACTION gr	MATERIAL
21.44.250	2.50	2	129	100	# 0.6 - 1.2	FUJI STAINLESS SIC	FUJI	EGI 2.0 - 4.0	CARBON

## MATCH RODS

### HELUROS MATCH



CODE	LENGTH OPEN m	PCS	LENGTH CLOSED cm	WEIGHT gr	ACTION gr	MATERIAL
21.32.400	4,00	4	110	220	5-15	CARBON IM 7

### TSERY MATCH



CODE	LENGTH OPEN m	PCS	LENGTH CLOSED cm	WEIGHT gr	ACTION gr	MATERIAL
21.23.420	4,20	3	145	230	10-30	CARBON

### CRYSTAL MATCH



CODE	LENGTH OPEN m	PCS	LENGTH CLOSED cm	WEIGHT gr	ACTION gr	MATERIAL
21.22.390	3,90	3	136	220	5-15	CARBON

## LEXUS MATCH



CODE	LENGTH OPEN m	PCS	LENGTH CLOSED cm	WEIGHT gr	ACTION gr	MATERIAL
21.12.420	4,20	3	146	300	5-15	CARBON

## VENUS MATCH



CODE	LENGTH OPEN m	PCS	LENGTH CLOSED cm	WEIGHT gr	ACTION gr	MATERIAL
21.13.420	4,20	4	133	180	10-30	CARBON

## VIANO MATCH



CODE	LENGTH OPEN m	PCS	LENGTH CLOSED cm	WEIGHT gr	ACTION gr	MATERIAL
21.41.420	4,20	3	144	205	5-25	IM-8 GRAPHITE

## TIGRA MATCH



CODE	LENGTH OPEN m	PCS	LENGTH CLOSED cm	WEIGHT gr	ACTION gr	MATERIAL
21.40.420	4,20	3	144	195	5-15	IM-8 GRAPHITE

## REGAL MATCH



CODE	LENGTH OPEN m	PCS	LENGTH CLOSED cm	WEIGHT gr	ACTION gr	MATERIAL
21.42.420	4,20	4	115	200	10-30	CARBON IM 8

## SPINNING RODS

### PARTNER



CODE	LENGTH OPEN m	PCS	LENGTH CLOSED cm	WEIGHT gr	ACTION gr	MATERIAL
21.33.210	2,10	2	110	130	5-20	IM 10 GRAPHITE NANO TECHNOLOGY FAST ACTION
21.33.240	2,40	2	125	145	5-20	IM 10 GRAPHITE NANO TECHNOLOGY FAST ACTION
21.33.270	2,70	2	140	170	5-20	IM 10 GRAPHITE NANO TECHNOLOGY FAST ACTION
21.33.300	3,00	2	155	190	5-20	IM 10 GRAPHITE NANO TECHNOLOGY FAST ACTION

### RYAN



CODE	LENGTH OPEN m	PCS	LENGTH CLOSED cm	WEIGHT gr	ACTION gr	MATERIAL
21.31.210	2,10	7	49	120	6-25	IM-7 CARBON
21.31.240	2,40	8	50	130	6-25	IM-7 CARBON
21.31.270	2,70	8	54	140	6-25	IM-7 CARBON

### BLACK SPIN



CODE	LENGTH OPEN m	PCS	LENGTH CLOSED cm	WEIGHT gr	ACTION gr	MATERIAL
21.17.240	2,40	2	124	185	10-40	CARBON NANO TECHNOLOGY
21.17.270	2,70	2	140	230	10-40	CARBON NANO TECHNOLOGY
21.17.300	3,00	2	154	260	10-40	CARBON NANO TECHNOLOGY

### KRAFT SPIN



CODE	LENGTH OPEN m	PCS	LENGTH CLOSED cm	WEIGHT gr	ACTION gr	MATERIAL
21.18.240	2,40	2	124	180	10-30	CARBON
21.18.270	2,70	2	140	210	10-30	CARBON
21.18.300	3,00	2	154	250	10-30	CARBON

## SHUTTLE SPIN



CODE	LENGTH OPEN m	PCS	LENGTH CLOSED cm	WEIGHT gr	ACTION gr	MATERIAL
21.24.240	2,40	2	124	185	20-70	CARBON NANO TECHNOLOGY
21.24.270	2,70	2	140	230	20-70	CARBON NANO TECHNOLOGY
21.24.300	3,00	2	154	265	20-70	CARBON NANO TECHNOLOGY

## BOAT JIGGING RODS

### AEGEAN SLOW PITCH



CODE	LENGTH OPEN m	PCS	LENGTH CLOSED cm	WEIGHT gr	ACTION gr	MATERIAL
21.25.198	1,98	2	138	165	50-180	NANO CHEMICAL TECHNOLOGY

### EXPERT LIGHT JIG



CODE	LENGTH OPEN m	PCS	LENGTH CLOSED cm	WEIGHT gr	ACTION gr	MATERIAL
21.14.200	2,00	2	118	135	180	CARBON

### PERFECT TAI RUBBER



CODE	LENGTH OPEN m	PCS	LENGTH CLOSED cm	WEIGHT gr	ACTION gr	MATERIAL
21.26.200	2,00	2	144	170	200	CARBON

### SLOW PITCH JIG



CODE	LENGTH OPEN m	PCS	LENGTH CLOSED cm	WEIGHT gr	ACTION gr	MATERIAL
21.19.195	1,95	2	139	175	50-200	CARBON NANO TECHNOLOGY

### TORZITE



CODE	LENGTH OPEN m	PCS	LENGTH CLOSED cm	WEIGHT gr	ACTION gr	MATERIAL
21.20.150	1,50	2	91	155	30-150	CARBON NANO TECHNOLOGY
21.20.180	1,80	2	122	160	40-180	CARBON NANO TECHNOLOGY
21.20.210	2,10	2	150	195	40-180	CARBON NANO TECHNOLOGY

## MAGIC SHORE JIG



CODE	LENGTH OPEN m	PCS	LENGTH CLOSED cm	WEIGHT gr	ACTION gr	MATERIAL
21.15.270	2,70	2	140	230	30-110	CARBON

## BOAT RODS

### MIRON



CODE	LENGTH OPEN m	PCS	LENGTH CLOSED cm	WEIGHT gr	ACTION gr	MATERIAL
21.07.150	1,50	1		230	20-100	CARBON

### MENOS



CODE	LENGTH OPEN m	PCS	LENGTH CLOSED cm	WEIGHT gr	ACTION gr	MATERIAL
21.06.150	1,50	1		265	30-150	CARBON

### SQUID BOAT



CODE	LENGTH OPEN m	PCS	LENGTH CLOSED cm	WEIGHT gr	ACTION gr	MATERIAL
21.27.180	1,80	2	92	135	20-100	CARBON
21.27.210	2,10	2	109	180	20-100	CARBON

### POSEIDON



CODE	LENGTH OPEN m	PCS	LENGTH CLOSED cm	WEIGHT gr	ACTION gr	MATERIAL
21.16.120	1,20	1	120	160		SOLID FIBRE

## POLE RODS

### HARMIS



CODE	LENGTH OPEN m	PCS	LENGTH CLOSED cm	WEIGHT gr	ACTION gr	MATERIAL
21.04.300	3,00	3	114	125	5-25	FIBRE GLASS
21.04.400	4,00	4	114	230	5-25	FIBRE GLASS
21.04.500	5,00	5	114	360	5-25	FIBRE GLASS
21.04.600	6,00	6	115	490	5-25	FIBRE GLASS
21.04.700	7,00	7	115	625	5-25	FIBRE GLASS
21.04.800	8,00	8	115	880	5-25	FIBRE GLASS

### SUPREMA POLE



CODE	LENGTH OPEN m	PCS	LENGTH CLOSED cm	WEIGHT gr	ACTION gr	MATERIAL
21.35.600	6,00	6	130	220	10-30	IM 10 GRAPHITE
21.35.700	7,00	7	130	280	10-30	IM 10 GRAPHITE
21.35.800	8,00	8	130	330	10-30	IM 10 GRAPHITE

## HEAVY CASTING RODS

### DENTEX HEAVY CASTING

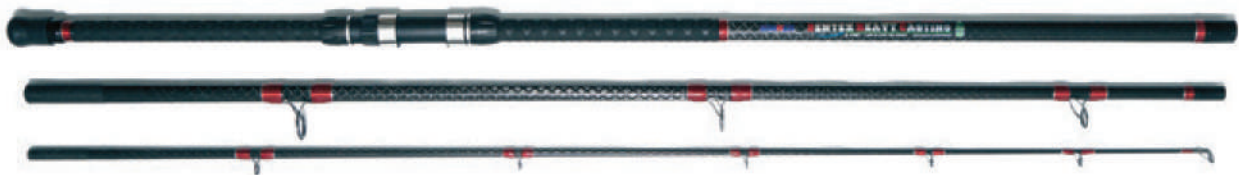

CODE	LENGTH OPEN m	PCS	LENGTH CLOSED cm	WEIGHT gr	ACTION gr	MATERIAL
21.08.420	4,20	3	152	875	250	CARBON

## SURF CASTING RODS

### DREAM SURF



CODE	LENGTH OPEN m	PCS	LENGTH CLOSED cm	WEIGHT gr	ACTION gr	MATERIAL
21.10.420	4,20	4	148	560	150	CARBON

### GALAXY SURF



CODE	LENGTH OPEN m	PCS	LENGTH CLOSED cm	WEIGHT gr	ACTION gr	MATERIAL
21.09.420	4,20	5	153	400	150	CARBON

## REAL MASTER SURF



CODE	LENGTH OPEN m	PCS	LENGTH CLOSED cm	WEIGHT gr	ACTION gr	MATERIAL
21.11.420	4,20	5	148	495	200	CARBON

## SUPERIOR SURF



CODE	LENGTH OPEN m	PCS	LENGTH CLOSED cm	WEIGHT gr	ACTION gr	MATERIAL
21.38.420	4,20	5	148	400	120	IM-6 CARBON

## MISTRA SURF



CODE	LENGTH OPEN m	PCS	LENGTH CLOSED cm	WEIGHT gr	ACTION gr	MATERIAL
21.39.420	4,20	5	148	415	150	IM-6 CARBON

## AEOLUS SURF



CODE	LENGTH OPEN m	PCS	LENGTH CLOSED cm	WEIGHT gr	ACTION gr	MATERIAL
21.43.420	4,20	5	145	445	100-200	IM-6 CARBON

## BOLOGNESE RODS

### SUPREMA BOLO



CODE	LENGTH OPEN m	PCS	LENGTH CLOSED cm	WEIGHT gr	ACTION gr	MATERIAL
21.36.500	5,00	5	140	200	10-30	IM 10 GRAPHITE
21.36.600	6,00	6	140	260	10-30	IM 10 GRAPHITE
21.36.700	7,00	7	140	320	10-30	IM 10 GRAPHITE

## RODS FOR LANDING NET

### ENDURE



CODE	TYPE	LENGTH OPEN m	PCS	LENGTH CLOSED cm	WEIGHT gr	ACTION gr	MATERIAL
21.21.300	TELESCOPIC	3,00	3	112	340		CARBON NANO TECHNOLOGY
21.21.400	TELESCOPIC	4,00	4	112	485		CARBON NANO TECHNOLOGY

### FEDROS



CODE	TYPE	LENGTH OPEN m	PCS	LENGTH CLOSED cm	WEIGHT gr	ACTION gr	MATERIAL
21.05.300	PUT OVER	3,00	3	117	145	30-80	CARBON
21.05.400	PUT OVER	4,00	4	117	165	50-100	CARBON

## CASTING RODS

### TELLIS



CODE	LENGTH OPEN m	PCS	LENGTH CLOSED cm	WEIGHT gr	ACTION gr	MATERIAL
21.00.180	1,80	6	40	115	10-40	FIBRE GLASS
21.00.210	2,10	7	42	145	10-40	FIBRE GLASS
21.00.240	2,40	8	42	180	10-40	FIBRE GLASS
21.00.270	2,70	9	45	230	10-40	FIBRE GLASS
21.00.300	3,00	10	45	265	10-40	FIBRE GLASS

### THALPIS



CODE	LENGTH OPEN m	PCS	LENGTH CLOSED cm	WEIGHT gr	ACTION gr	MATERIAL
21.01.270	2,70	5	70	285	40-80	FIBRE GLASS
21.01.300	3,00	5	70	300	40-80	FIBRE GLASS
21.01.330	3,30	6	70	375	40-80	FIBRE GLASS
21.01.360	3,60	6	70	405	40-80	FIBRE GLASS



CODE	LENGTH OPEN m	PCS	LENGTH CLOSED cm	WEIGHT gr	ACTION gr	MATERIAL
21.02.270	2,70	5	70	310	50-100	FIBRE GLASS
21.02.300	3,00	5	70	330	50-100	FIBRE GLASS
21.02.330	3,30	6	70	420	50-100	FIBRE GLASS
21.02.360	3,60	6	70	440	50-100	FIBRE GLASS



CODE	LENGTH OPEN m	PCS	LENGTH CLOSED cm	WEIGHT gr	ACTION gr	MATERIAL
21.03.270	2,70	5	84	300	75-150	FIBRE GLASS
21.03.300	3,00	5	84	330	75-150	FIBRE GLASS
21.03.360	3,60	6	86	445	75-150	FIBRE GLASS

## REELS

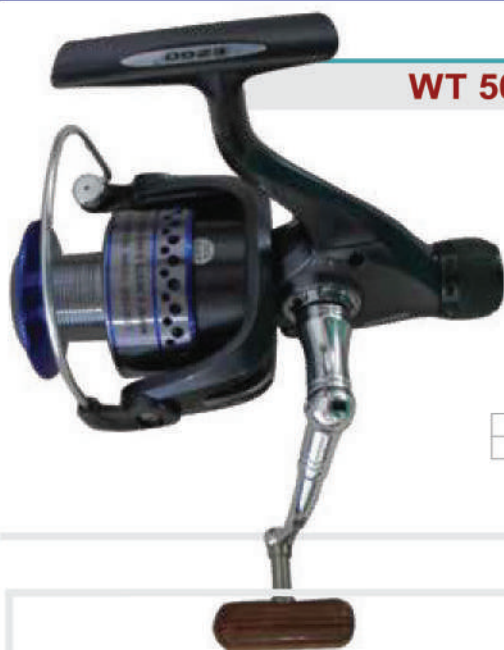

**WT 5000**



Code	Model No	Gear Rat.	B.B.	Weight	Line Capacity (mm/m)	Max Drag (kg)
00.91.001	WT 5000	4,7	2	425gr	0,35/275 0,40/210 0,50/135	6

**WN 1000**



Code	Model No	Gear Rat.	B.B.	Weight	Line Capacity (mm/m)	Max Drag (kg)
00.92.001	WN 1000	4,7	9	215gr	0,18/215 0,20/175 0,25/110	4





### WST 9000



Racht-exact



High-powered



Clam-brake



Design-light



Stabilization system



Smooth-wrap



Quality assurance

- 6+1 Ball Bearings (Stainless Steel)
- Powerful Gear and Pinion
- Worm Shaft System Structure
- Super Large size Surf Reel Based
- For Improved Corrosion Resistance
- CNC Aluminum Handle and Aluminum Spool
- Stainless Steel Main Shaft and Drag Washer

Code	Model No	Gear Rat.	B.B.	B.R.	Weight	Line Capacity (mm/m)	Max Drag (kg)
21.80.002	WST 9000	4.8:1	6	1	580 gr	0,35/310-0,40/240-0,50/180	22



Racht-exact



High-powered



Clam-brake



Design-light



Stabilization system



Smooth-wrap



Quality assurance

Code	Model No	Gear Rat.	B.B.	B.R.	Weight	Line Capacity (mm/m)	Max Drag (kg)
21.81.001	WLY 1000M	5.2:1	5	1	220kg	0,24/135 - 0,28/105 - 0,33/85	6

### WLY 1000M

- 5+1 Ball Bearings
- Powerful Gear and Pinion
- With no An-Ti Reverse Structure
- Quality Ball Bearings Provides
- CNC Aluminum Handle
- The Thickened Main Shaft Make the Fishing Reel More Stable
- Long Foot Design to ensure the comfort of Fishing



### WRT 4000M



BEARINGS



ONE WAY



AVS ANTI VIBRO



ANTI TWIST



SPOOL

- 3+1 ball bearings
- Powerful drive gear
- CNC aluminum spool
- Super light graphite body
- gear ratio 5.0:1
- Right & left interchangeable handle

Code	Model No	Gear Rat.	B.B.	B.R.	Weight	Line Capacity (mm/m)	Max Drag (kg)
21.82.001	WRT 4000M	5.2:1	3	1	255kg	0,24/150 - 0,27/130 - 0,30/100	8



CDS 16<sup>KG</sup>



GEAR RATIO  
6.5:1



86cm

- 6+1 Ball Bearings (Stainless Steel)
- Carbon Fiber Raw Material
- Carved Aluminum Spool
- High Strength Aluminum Bronze Main
- Frame/side plate are carbon fiber material

Code	Model No	Gear Rat.	B.B.	B.R.	Weight	Line Capacity (mm/m)	Max Drag (kg)
21.83.001	WBZ 400R	6.5:1	6	1	280kg	0,30/245 - 0,35/215 - 0,40/185	16

Code	Model No	Gear Rat.	B.B.	B.R.	Weight	Line Capacity (mm/m)	Max Drag (kg)
21.83.002	WBZ 400L	6.5:1	6	1	280kg	0,30/245 - 0,35/215 - 0,40/185	16



### WBZ 400

## ROD BAGS



CODE: 13.24.000    LENGTH: 1,57 m

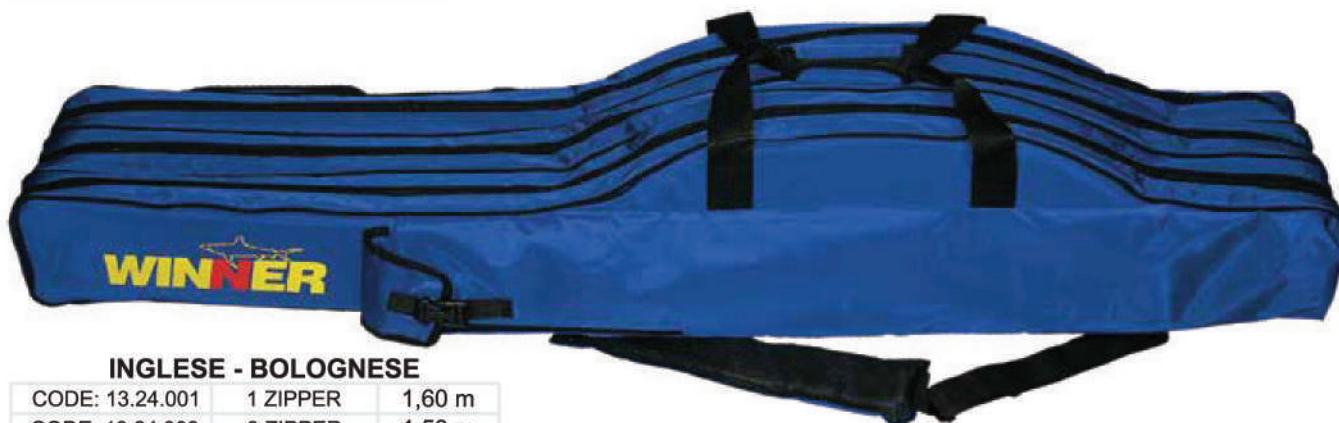

### INGLESE - BOLOGNESE

CODE: 13.24.001    1 ZIPPER    1,60 m

CODE: 13.24.003    3 ZIPPER    1,50 m



### SURF CASTING (1 ZIPPER)

CODE: 13.21.000    BLUE    1,60 m

CODE: 13.21.001    BLUE    2,10 m



### SURF CASTING (2 ZIPPER)

CODE: 13.22.000    BLUE    1,75 m



### SURF CASTING (4 ZIPPER)

CODE: 13.23.000    BLUE    1,75 m



# HOOKS

# WINNER

## SOI W/RING

ART. 8017 CODE: 03.59.\*\*\*



5/0



6/0



7/0



8/0



9/0



10/0



11/0

BLACK  
NICKEL  
COLOR



BOX 100 PCS

### 1540 N CHINU



CODE: 03.10.\*\*\*

COLOR

NICKEL

SIZE

1 - 2 - 3 - 4  
5 - 6 - 7 - 8

### 1540 B CHINU



CODE: 03.11.\*\*\*

COLOR

BROWN

SIZE

1 - 2 - 3 - 4  
5 - 6 - 7 - 8

### 1550 N CHINU W/RING



CODE: 03.12.\*\*\*

COLOR

NICKEL

SIZE

3/0 - 2/0 - 1/0  
1 - 2 - 3 - 4 - 5 - 6 - 7 - 8

**ISEAMA 6410 BN**

CODE: 03.00.\*\*\*



BLACK  
NICKEL  
COLOR

10 9 8 7 6 5 4 3 2 1

**ISEAMA 6410 BN**



1/0 2/0 3/0

**ISEAMA W/RING 6415 BN**

CODE: 03.87.\*\*\*

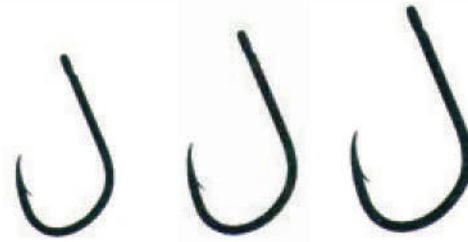

BLACK  
NICKEL  
COLOR

2/0 3/0 4/0

**SODE 6460 BN**

CODE: 03.05.\*\*\*



BLACK  
NICKEL  
COLOR

11 10 9 8 7 6 5 4 3 2

**MARUSEIGO W/RING 6440 BN**

CODE: 03.03.\*\*\*



BLACK  
NICKEL  
COLOR

8 7 6 5 4 3 2 1

**MARUSEIGO 6420 BN**

CODE: 03.01.\*\*\*



BLACK  
NICKEL  
COLOR

7 6 5 4 3 2 1

MARUSEIGO - BH 6490

CODE: 03.07.\*\*\*



8 7 6 5 4 3 2 1



COLOR

CHINU 6430 BN

CODE: 03.02.\*\*\*



10 9 8 7 6 5 4 3 2 1 1/0 2/0 3/0



COLOR

ABERDEEN 7425 N

CODE: 03.09.\*\*\*



8 6 4 2 1



XPQMA

BIGATTINI 6465 W/RING

CODE: 03.24.\*\*\*



14 12 11 10 9 8



COLOR

CHINU W/RING 6450 BN

CODE: 03.04.\*\*\*



9 8 7 6 5 4 3 2 1 1/0 2/0 3/0 4/0 5/0 6/0



COLOR

IZUMEZINA 7415

CODE: 03.08.\*\*\*



8 7 6 5 4 3 2



COLOR

**MUTSU 6480 BN**

CODE: 03.50.\*\*\*



5 4 3 2 1

COLOR

**MUTSU W/RING 6485 BN**

CODE: 03.86.\*\*\*



4 3 2

COLOR

**RYUSEN TWO SLICED 6520 BN**

CODE: 03.92.\*\*\*

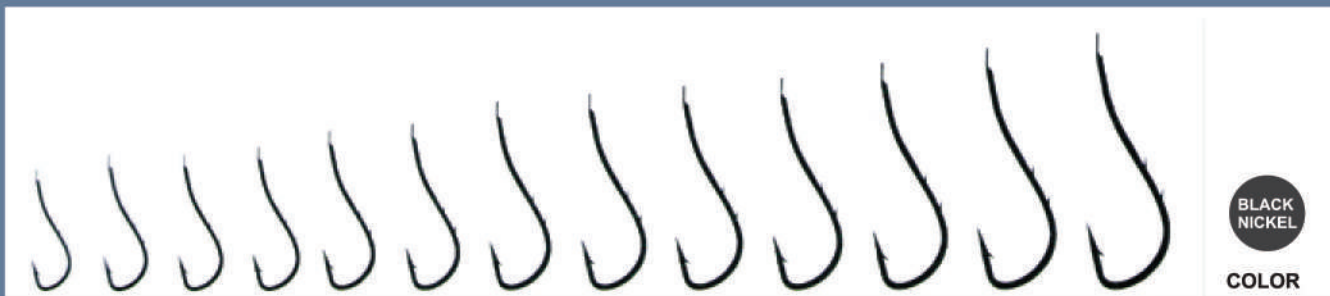

11 10 9 8 7 6 5 4 3 2 1 1/0 2/0

COLOR

**AKITA KITSUNE 6510 BN**

CODE: 03.91.\*\*\*



13 12 11 10 9 8 7 6 5 4

COLOR

**SB CHINU 6530 BN**

CODE: 03.93.\*\*\*



10 8 6 5 4 3 2

COLOR



**NEMURI SEIGO 6540 BN**

CODE: 03.94.\*\*\*





5 4 3 2 1 1/0

COLOR

<b>Jig hook z1</b> 1 gr - 5 pcs/box Hook size 1,2,3,4,5, 6,7,8 code 12.62.***		<b>Jig hook z2</b> 1,5 gr - 5pcs/box Hook size 1/0,1,2,3,4, 5,6,7,8 code 12.63.***		<b>Jig hook z3</b> 3,5 gr – 5pcs/box Hook size 1/0,1,2,3,4, 5,6,7,8 code 12.50.***	
--	---	---	---	---	---

<b>Jig hook z5</b> 5,3 gr - 5 pcs/box Hook size 1/0,1,2,3,4,5, 6,7,8 code 12.51.***		<b>Jig hook z4</b> 3,6 gr - 5 pcs/box Hook size 1/0,1,2,3,4, 5,6,7,8 <b>code 12.52.***</b>		<b>Jig hook z6</b> 5,6 gr - 5 pcs/box Hook size 1/0,1,2,3,4, 5,6,7,8 code 12.53.***	
--	---	---	---	--	---

<b>Jig hook z7</b> 7 gr - 4 pcs/box Hook size 2/0,1/0,1,2,3 code 12.64.***		<b>Jig hook z7s</b> 7 gr - 4 pcs/box Hook size 2/0,1/0,1 code 12.65.***		<b>Jig hook z13</b> 13 gr - 3 pcs/box Hook size 3/0,2/0,1/0,1 code 12.57.***	
--	---	---	---	--	---

<b>Jig hook z16</b> 15,6 gr - 3 pcs/box Hook size 4/0,3/0,2/0,1/0,1,2,3 code 12.54.***		<b>Jig hook z22</b> 22 gr - 3 pcs/box Hook size 5/0,4/0,3/0,2/0,1/0,1,2,3 code 12.58.***	
--	---	--	---

<b>Jig hook z27</b> 26,7gr - 3 pcs/box Hook size 5/0,4/0,3/0,2/0,1/0,1 code 12.55.***		<b>Jig hook z38</b> 38,2gr - 3 pcs/box Hook size 5/0,4/0,3/0,2/0,1/0,1 code 12.56.***	
---	--	---	--

**Jig hooks with swarovski beads**

					
<b>Jig hook zs22</b> 22gr – beads 6mm - 2pcs/box Hook size 9/0,8/0,7/0 code 12.59.***	22 gr	<b>Jig hook zs38</b> 150gr - beads 8mm - 2pcs/box Hook size 8/0 code 12.60.***	38 gr	<b>Jig hook zs75</b> 75gr – beads 10mm – 2pcs/box Hook size 8/0 code 12.61.***	75 gr

				
<b>Jig hook z85</b> 85gr Hook size 9/0,8/0,7/0 code 12.47.***	<b>Jig hook z150</b> 150gr Hook size 8/0 code 12.37.***	<b>Jig hook z180</b> 180gr Hook size 8/0 code 12.66.***	<b>Jig hook z200</b> 200gr Hook size 10/0,9/0,8/0 code 12.42.***	<b>Jig hook z415</b> 415gr Hook size 12/0,11/0,10/0,9/0,8/0 code 12.39.***

*Effectively designed for both internal and sea water, it's the ideal tool for all kinds of fishing.  
 All jig hooks are electroplated*

## BAREL SWIVEL

CODE: 04.00.\*\*\*



	12	10	9	8	7	6	5	4	3	2	1	1/0	2/0	3/0
TEST /KG	14	16	18	20	23	27	28	30	35	46	48	53	55	60

## BAREL SWIVEL W/H INTERLOCK SNAP

CODE: 04.05.\*\*\*

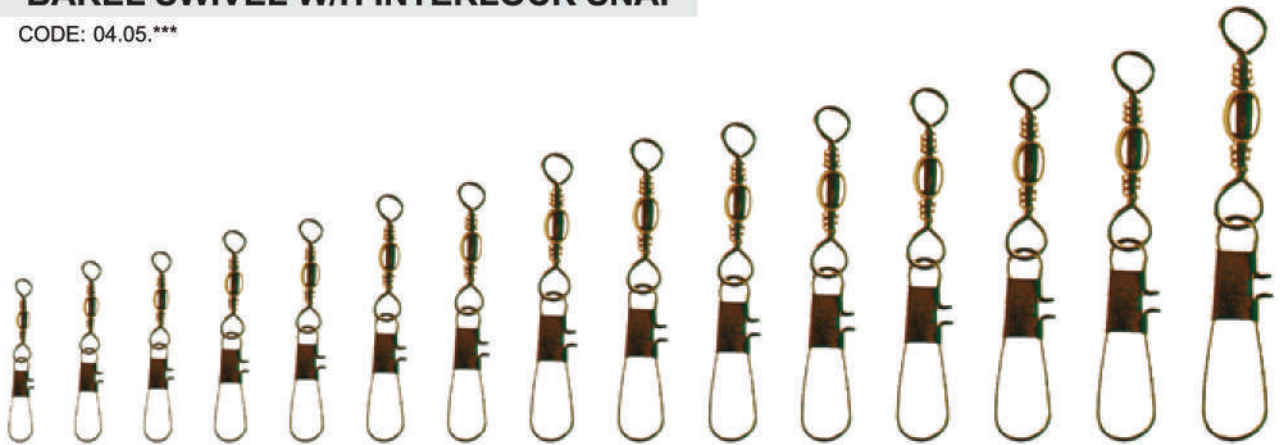

	20	18	16	14	12	10	9	8	7	6	5	4	3	2	1
TEST /KG	6	7	8	10	12	14	14	14	18	18	18	25	25	25	43

## ROLLING SWIVEL ROULETTE BODY

CODE: 04.03.\*\*\*



	14	12	10	8	7	6	5	4	3	2	1
TEST /KG	4	9	14	19	22	30	32	35	40	43	47

## ROLLING SWIVEL W/HOOKED SNAP

CODE: 04.06.\*\*\*

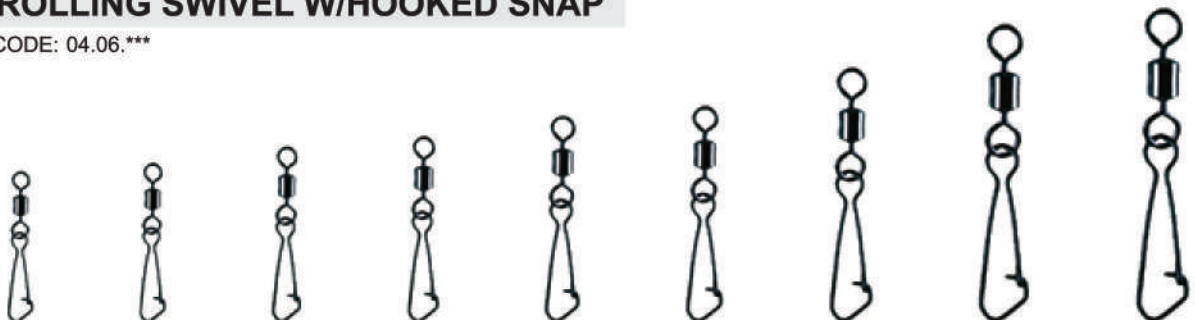

	10	8	7	6	5	4	3	2	1
TEST /KG	12	12	20	20	28	28	35	25	40

## HIGH SPEED TREBLE SWIVELS (ART W-210)

CODE: 04.20.\*\*\*



	14	12	10	8	7	6	5	4	3	2	1
TEST /KG	4	9	14	19	22	30	32	35	40	43	47

## DOUBLE ROLLING SWIVELS W/SCREENED SNAP (ART W-211)

CODE: 04.21.\*\*\*



	10	8	6	4	2	1/0	3/0
TEST /KG	14	19	27	35	43	60	100

## ROLLING SWIVELS W/FAST CLIP (ART W-212)

CODE: 04.22.\*\*\*



	10	8	6	4	2
TEST /KG	5	10	14	18	23

## T - ROLLING SWIVELS (ART W-213)

CODE: 04.23.\*\*\*



	2/0-16mm	1-1.4mm	3-1.2mm	5-1.00mm	7-0.8mm	10-0.6mm	12-0.4mm
TEST /KG	75	47	40	32	22	19	14

## HANGING SNAP (ART W-214)

CODE: 04.24.\*\*\*

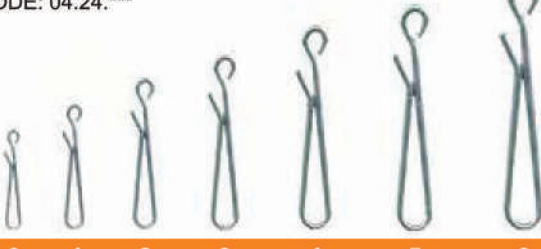

	0	1	2	3	4	5	6
TEST /KG	5	10	14	18	23	28	35

## THREE WAY DUTY SWIVELS (ART W-215)

CODE: 04.25.\*\*\*



	3	2	1
TEST /KG	19	14	9

### TRIPLE SWIVEL WITH BEADS

CODE: 04.12.\*\*\* LUM BEADS  
 CODE: 04.44.\*\*\* RED BEADS



	14	12	10	8	7	6
TEST /KG	10	14	16	20	24	27

### TRIPLE BAREL SWIVEL

CODE: 04.11.\*\*\*



	10	8	6	5	4	3	2	1
TEST /KG	16	20	27	28	30	31	46	48

### HOOKED SNAP

CODE: 04.07.\*\*\*

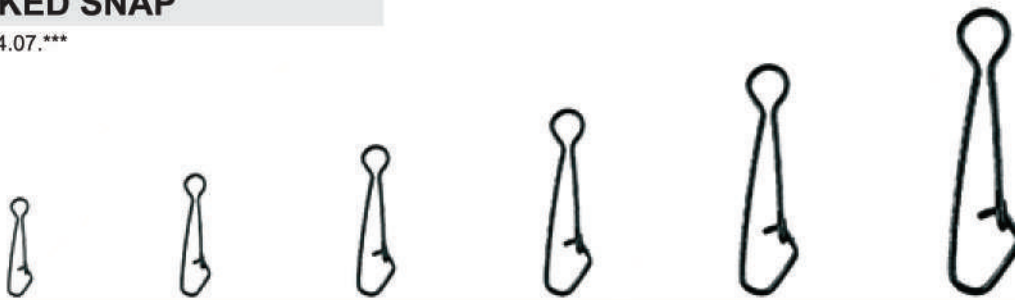

	1	2	3	4	5	6
TEST /KG	20	28	35	40	45	60

### INTERLOCK SNAP

CODE: 04.08.\*\*\* BLACK  
 CODE: 04.17.\*\*\* BRASS



	1	2	3	4	5	6
TEST /KG	12	14	18	25	43	60

### DOUBLE ROLLING SWIVEL W/FAST CLIP

ART W-232  
 CODE: 04.31.\*\*\*



	8	6	4	2
TEST /KG	19	30	35	43

### CONNECTION SNAP (W-233)

CODE: 04.32.002    CODE: 04.32.001



L    S

### SPLIT RING

CODE: 15.23.\*\*\*



4,5    5    6    7    8

# T - ROLLING CROSS-LINE SWIVEL PEARL BEADS (ART-216)

CODE: 04.26.\*\*\*



No	1/0	2	4
TEST /KG	47	40	32



No	6	8	10
TEST /KG	22	14	9

## CLOSE EYE SNAP W/SWIVEL (ART-219)

CODE: 04.27.\*\*\*



1,8 X 60 mm    2,0 X 80 mm

## CLOSE EYE SNAP (ART-218)

CODE: 04.28.\*\*\*

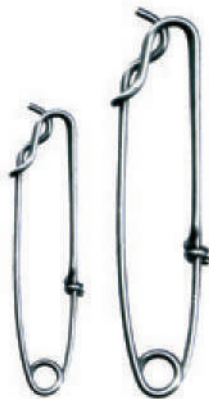

1,8 X 60 mm    2,0 X 80 mm

## HANGING SNAP

ART W-220    ART W-172  
CODE: 04.30.004    CODE: 04.34.000

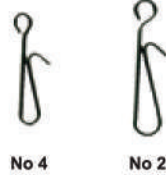

No 4    No 2

## WRAPPING SNAP (ART W-217)

CODE: 04.29.\*\*\*



	XXL	XL	L	M	S
TEST /KG	40	35	25	18	12

## NICE SNAP W-203

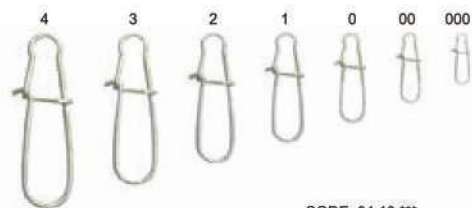

CODE: 04.10.\*\*\*

SIZE	000	00	0	1	2	3	4
TEST/Kg	4	9	12	18	25	30	35

## ROLLING SWIVEL WITH NICE SNAP W-202

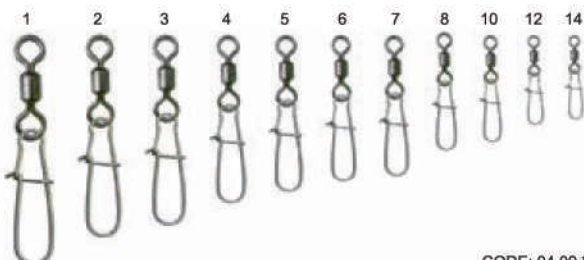

CODE: 04.09.\*\*\*

SIZE	1	2	3	4	5	6	7	8	10	12	14
TEST/Kg	35	30	30	25	25	18	18	12	12	9	4

## QUICK CHANGE SWIVEL (ART W-204)

CODE: 04.16.\*\*\*



SIZE	12	14
------	----	----

# FLURO CARBON LINES



## SUPER HARD CARBON

CODE: 02.68.\*\*\*

		SPOOL 50m					
mm		0,104	0,122	0,135	0,159	0,177	0,198
Test/Kg		2,34	2,52	2,64	3,36	3,96	4,56
mm		0,218	0,255	0,273	0,303	0,341	0,381
Test/Kg		5,45	6,25	8,14	9,95	12,40	14,85



## EXTREME FLURO CARBON

CODE: 02.67.\*\*\*

		SPOOL 50m					
mm		0,122	0,135	0,159	0,177	0,198	0,218
Test/Kg		2,55	3,70	4,70	5,30	5,90	6,50
mm		0,255	0,273	0,303	0,340	0,380	
Test/Kg		7,30	8,15	10,00	12,50	14,90	



## HARD - ROCK

FLUROCARBON 100%

CODE: 02.34.\*\*\*

mm	0,100	0,135	0,165	0,185	0,205	0,245
Test/Kg						
mm	0,285	0,310	0,370	0,405	0,500	0,600
Test/Kg						

# FISHING LINES

## PLANET

CODE: 02.69.\*\*\*



		SPOOL 150m					
mm		0,165	0,185	0,205	0,235	0,250	0,300
Test/Kg		3,65	4,15	6,35	7,63	9,15	12,24
mm		0,350	0,400				
Test/Kg		15,70	16,80				

## PRESTIGE

CODE: 02.70.\*\*\*



		SPOOL 100m					
mm		0,18	0,20	0,22	0,24	0,26	0,28
Test/Kg		3,86	5,42	6,55	7,56	8,82	11,12
mm		0,30	0,35	0,40			
Test/Kg		11,34	12,64	15,60			

## MATCH

COLOR: SKY BLUE



		SPOOL 300m					CODE: 02.33.***
mm		0,148	0,165	0,185	0,205	0,235	
Test/Kg		2,90	3,80	4,20	6,00	8,30	
mm		0,260	0,280	0,310	0,370	0,405	
Test/Kg		9,70	12,20	13,90	14,70	17,20	

## MATCH SINKING

CODE: 02.71.\*\*\*



		SPOOL 150m				
mm		0,14	0,16	0,18	0,20	0,22
Test/Kg		2,80	3,60	4,70	5,60	7,10

**BLACK MATCH**

CODE: 02.23.\*\*\*



SPOOL 150m

mm	0,16	0,18	0,20	0,22
Test/Kg	3,00	4,00	4,80	5,20

**KAMISAMA**

COLOR: CLEAR



SPOOL 600m CODE: 02.31.\*\*\*

mm	0,26	0,28	0,30	0,35	0,40
Test/Kg	7,80	10,10	11,30	13,80	17,60
mm	0,45	0,50	0,60		
Test/Kg	24,20	25,30	31,40		

**KAMISAMA**

COLOR: CLEAR



SPOOL 100m CODE: 02.32.\*\*\*

mm	0,14	0,16	0,18	0,20	0,22	0,24	0,26
Test/Kg	2,40	3,10	3,70	4,60	5,70	6,20	7,80
mm	0,28	0,30	0,35	0,40	0,45	0,50	0,60
Test/Kg	10,10	11,30	13,80	17,60	24,20	25,30	31,40

**TK FISHING LINE**

COLOR: CLEAR

CODE: 02.18.\*\*\*



SPOOL 100m

mm	0,300	0,350	0,400	0,450	0,500	
mm	0,600	0,700	0,800	0,900	1,000	1,200

**HOLLOW BRAID FOR ASSIST HOOKS**

**SHOCK LEADER**

(5 pcs x 15m)



CODE: 02.48.\*\*\*

SIZE	0,23/57	0,28/57	0,33/57	0,37/57
------	---------	---------	---------	---------

**KEVLAR**



RED/WHITE 20 m 120 lbs  
CODE: 14.54.001



YELLOW 20 m 150 lbs  
CODE: 14.54.002

# DYNEEMA



## TITAN PE9

CODE: 02.65.\*\*\*  
MULTICOLOR

SPOOL 200m

mm	0,12	0,14	0,16	0,18	0,20	0,23	0,26
Test/Kg	5,20	6,90	8,90	9,70	11,50	13,45	16,50



## TITAN PE9

CODE: 02.66.035  
MULTICOLOR

SPOOL 600m

mm	0,35
Test/Kg	28,15

## WINNER TOP

COLOR: GREY



SPOOL 100m

CODE: 02.51.\*\*\*

mm	0,15	0,19	0,22	0,25	0,30	0,35	0,40	0,44	0,48
Test/Kg	7,5	10,8	12,4	15,1	18,6	23,1	29,1	35,6	40,2

## MOBYDICH

COLOR: GREY



SPOOL 600m

4 BRAID

CODE: 02.47.\*\*\*

mm	0,150	0,190	0,220	0,250	0,290
Test/Kg	7,500	10,800	12,400	15,100	18,600

8 BRAID

mm	0,350	0,400	0,440	0,480
Test/Kg	23,100	29,100	35,600	40,200

## FISHING FLOATS

**W-1 ø 4,5**

CODE: 19.23.\*\*\*



WEIGHT	2+1, 2+2, 3+1, 3+2, 3+3, 4+1, 4+2, 4+3, 5+1, 5+2, 5+3, 6+1, 6+2
DESCRIPTION	WITH SOCKET FOR CHEMICAL LIGHT INGLESE

**PSV. 07**

CODE: 19.08.003



WEIGHT	3 gr
DESCRIPTION	WITH SOCKET FOR CHEMICAL LIGHT

**PSV. 36**

CODE: 19.09.\*\*\*



WEIGHT	4 gr - 5 gr
DESCRIPTION	WITH SOCKET FOR CHEMICAL LIGHT

**PSV. 38**

CODE: 19.10.006



WEIGHT	6 gr
DESCRIPTION	WITH SOCKET FOR CHEMICAL LIGHT

**PSV. 40**

CODE: 19.11.\*\*\*



WEIGHT	3 gr - 4 gr - 5 gr - 6 gr - 8 gr
DESCRIPTION	WITH SOCKET FOR CHEMICAL LIGHT

**UFO 01**

CODE: 19.18.\*\*\*



WEIGHT	30 gr - 40 gr - 50 gr - 60 gr
DESCRIPTION	SLIDING

## FISHING FLOATS

**PSV. 44**

CODE: 19.12.\*\*\*



WEIGHT	1,5 gr - 2 gr - 3 gr - 4 gr - 5 gr
DESCRIPTION	WITH SOCKET FOR CHEMICAL LIGHT

**PSV. 61B**

CODE: 19.13.\*\*\*



WEIGHT	2 gr - 5 gr
DESCRIPTION	WITH SOCKET FOR CHEMICAL LIGHT

**PSV. 62B**

CODE: 19.15.\*\*\*



WEIGHT	1 gr - 2 gr - 3 gr - 4 gr - 5 gr - 6 gr - 8 gr
DESCRIPTION	WITH SOCKET FOR CHEMICAL LIGHT

**PSV. 64B**

CODE: 19.14.004



WEIGHT	4 gr
DESCRIPTION	WITH SOCKET FOR CHEMICAL LIGHT

**CEFALO**

CODE: 19.19.\*\*\*



WEIGHT	40 gr - 50 gr - 60 gr
DESCRIPTION	SLIDING

**PSV. 71B**

CODE: 19.16.\*\*\*



WEIGHT	2 gr - 3 gr - 5 gr - 6 gr - 8 gr
DESCRIPTION	WITH SOCKET FOR CHEMICAL LIGHT

## FISHING FLOATS

**SCI 03**

CODE: 19.01.\*\*\*



**SCI 05**

CODE: 19.02.\*\*\*



**SCI 09**

CODE: 19.00.\*\*\*

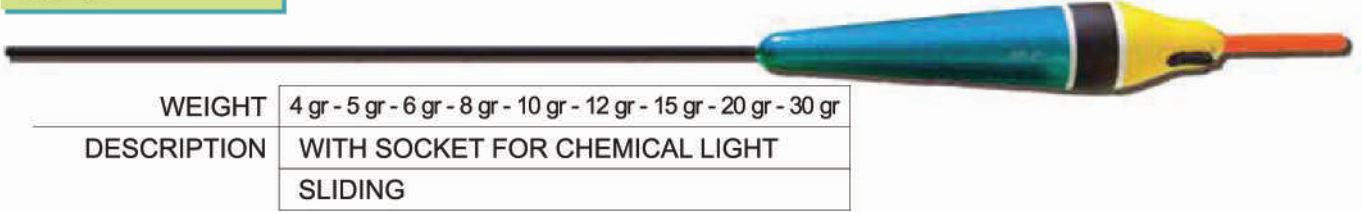

**SCI 12**

CODE: 19.03.\*\*\*

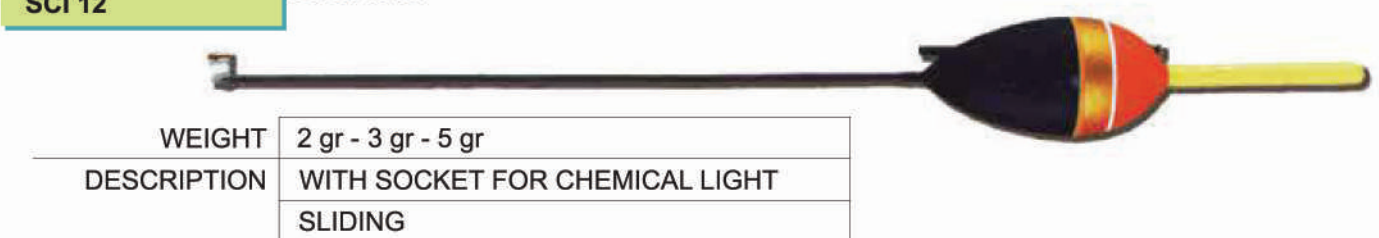

**SCI 13**

CODE: 19.04.\*\*\*

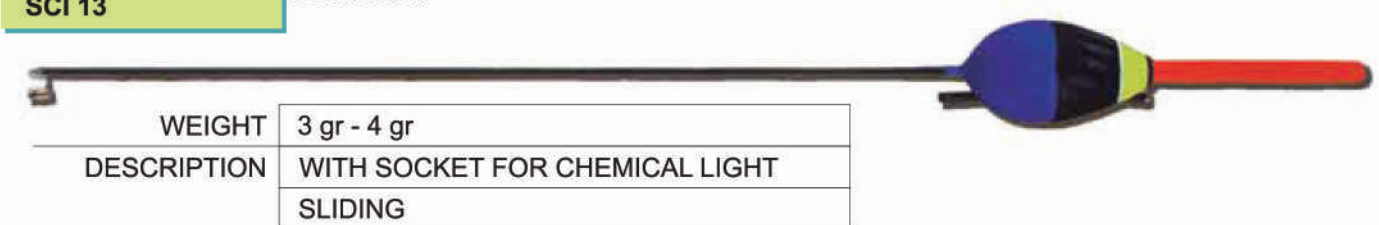

**SC.I. 08**

CODE: 19.05.\*\*\*

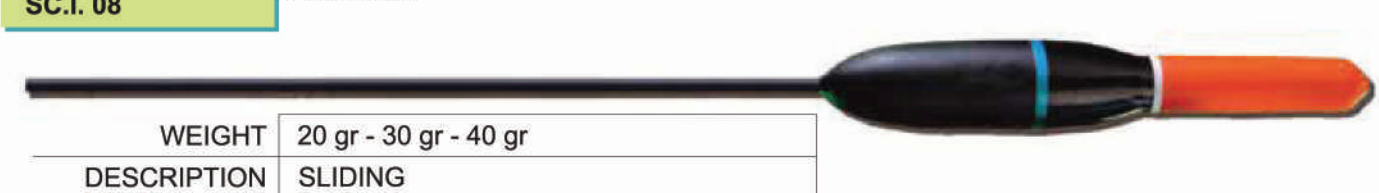

## FISHING FLOATS

**SCM. 03**

CODE: 19.06.\*\*\*



WEIGHT	2 gr - 3 gr
DESCRIPTION	SLIDING

**SC. PS. 05 B**

CODE: 19.07.\*\*\*



WEIGHT	2 gr - 3 gr
DESCRIPTION	WITH SOCKET FOR CHEMICAL LIGHT
	SLIDING

**V.M. 02**

CODE: 19.17.\*\*\*



WEIGHT	2 gr - 3 gr
--------	-------------

**FEEDER FLOAT**

CODE: 18.44.000



**BOMBARDA**

CODE: 18.51.\*\*\*



WEIGHT	40 gr - 50 gr
DESCRIPTION	SLIDING

**BOMBARDA**

LUMINOUS SINKING CODE: 18.58.\*\*\*

20 gr - 25 gr - 30 gr - 40 gr



TRANSPARENT SINKING CODE: 18.57.\*\*\*

10 gr - 15 gr - 20 gr - 25 gr - 30 gr - 40 gr



WHITE FLOAT CODE: 18.59.\*\*\*

20 gr - 25 gr - 30 gr - 40 gr

**MIX COLOR SILICON TUBE**

CODE: 18.52.001



51 - 2550

## FISHING FLOATS

**ART WF-4**

CODE: 19.27.\*\*\*



8 gr - 10 gr - 12 gr - 14 gr - 16 gr - 18 gr

**ART WF-6**

CODE: 19.29.\*\*\*



10 gr - 12 gr - 14 gr - 16 gr - 18 gr

**ART WF-5**

CODE: 19.28.\*\*\*



6 gr - 8 gr - 10 gr - 12 gr - 14 gr

**ART WF-7**

CODE: 19.30.\*\*\*



4+2 gr - 4+3 gr - 6+2 gr - 6+3 gr - 8+2 gr - 8+3 gr

**ART WF-3**

CODE: 19.26.\*\*\*



2+1 gr - 2+2 gr - 3+1 gr - 3+2 gr - 3+3 gr - 4+1 gr - 4+2 gr

4+3 gr - 5+1 gr - 5+2 gr - 5+3 gr - 6+1 gr - 6+2 gr - 6+3 gr

**ART WF-8**

CODE: 19.31.\*\*\*



6+1 gr - 8+1 gr - 10+2 gr - 12+2 gr

# SABIKI



**DPX**

CODE: 06.04.\*\*\*  
No 3 - 4 - 5 - 6 - 7 - 9 - 10



**WFN 600**

CODE: 06.00.008



**1006**

CODE: 06.00.003

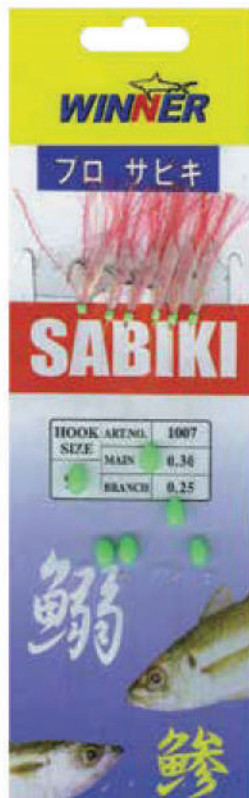

**1007**

CODE: 06.00.004



**1008**

CODE: 06.00.005



**BKF 801**

CODE: 06.00.012

# SABIKI



**A-1**  
CODE: 06.00.001

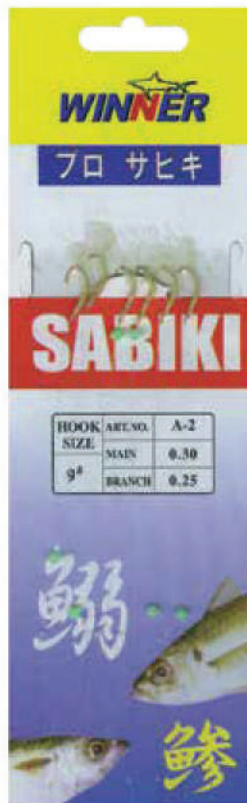

**A-2**  
CODE: 06.00.002



**FL 802**  
CODE: 06.00.011



**AKS 700**  
CODE: 06.00.009



**AS 600**  
CODE: 06.00.007

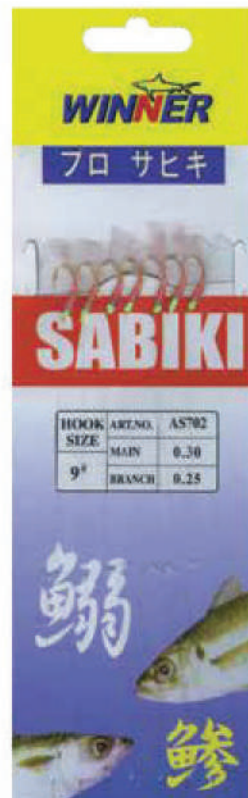

**AS 702**  
CODE: 06.00.010



**AS 804**  
CODE: 06.00.006

## PLASTIC LURE

LF 206 (25gr) CODE: 17.99.\*\*\*



L 02



L 05



L 04



L 06



L 03



L 01

## MICRO JIG



L 02

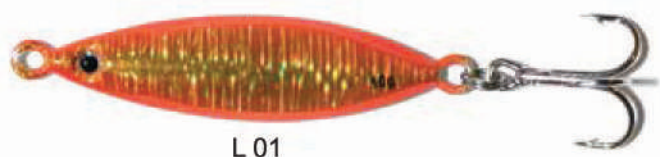

L 01



L 04

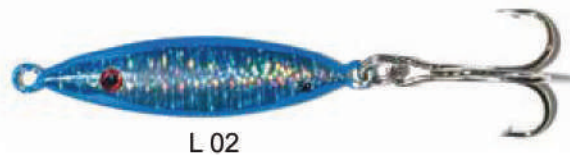

L 02



L 01



L 03



L 03



L 04



L 05



L 05

LF 201 (3gr) CODE: 17.93.\*\*\*  
 LF 201 (5gr) CODE: 17.94.\*\*\*  
 LF 201 (7gr) CODE: 17.95.\*\*\*  
 LF 201 (10gr) CODE: 17.96.\*\*\*  
 LF 201 (14gr) CODE: 17.97.\*\*\*  
 LF 201 (18gr) CODE: 17.98.\*\*\*

LF 149 (3gr) CODE: 17.87.\*\*\*  
 LF 149 (5gr) CODE: 17.88.\*\*\*  
 LF 149 (7gr) CODE: 17.89.\*\*\*  
 LF 149 (10gr) CODE: 17.90.\*\*\*  
 LF 149 (14gr) CODE: 17.91.\*\*\*  
 LF 149 (18gr) CODE: 17.92.\*\*\*

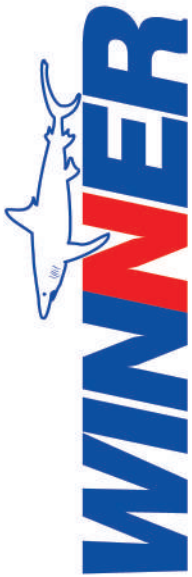

COLOR

TYPE: GO-028  
SINKING

LENGHT: 14,00 cm - WEIGHT: 45,80 gr

PLASTIC LURE

CODE: 05.06.\*\*\*

L 03F



L 11F



L 13F



L 28



L 36F



L 220























L 407























L RH















COLOR	TYPE: GO-011 FLOATING	LENGHT: 7,00 cm WEIGHT: 5,00 gr
	PLASTIC LURE	
L 03		CODE: 05.01.***
L 11		
L 17		
L 23		
L 36		
L 41A		
L 301N		
L 220		
L 304N		
L 305N		

COLOR	TYPE: K-182 FLOATING	LENGHT: 7,00 cm WEIGHT: 5,10 gr
	PLASTIC LURE	
L 13		CODE: 05.00.***
L 16		
L 23		
L 41		
L 71		
L 75		
L 82		
L 86		
L 91		
L 98		
L 220		

TYPE: 5256 SINKING		LENGHT: 80 mm WEIGHT: 23 gr
PLASTIC LURE		
L 12		CODE: 05.14.***
L 23		L CHR
L 51		L 26
		
		

COLOR	TYPE: GO-015 FLOATING	LENGHT: 9,00 cm WEIGHT: 7,10 gr
	PLASTIC LURE	
CODE: 05.03.***		
L 03		
L 11		
L 17		
L 23		
L 36		
L 41		
L 41A		
L 81		
L 83		
L 301N		
L 302N		
L 303N		
L 304N		
L 305N		
L 220		

COLOR	TYPE: K-188 FLOATING	LENGHT: 9,00 cm WEIGHT: 9,30 gr
	PLASTIC LURE	
CODE: 05.02.***		
L 11		
L 16		
L 23		
L 39		
L 41		
L 71		
L 75		
L 82		
L 86		
L 89		
L 91		
L 93		
L 98		

COLOR	TYPE: K-128 FLOATING	LENGHT: 13,00 cm WEIGHT: 26,90 gr
	PLASTIC LURE	
	CODE: 05.05.***	
L 11		
L 13		
L 16		
L 21		
L 23		
L 39		
L 41		
L 71		
L 75		
L 82		
L 86		
L 89		
L 91		
L 93		
L 98		
L 220		

COLOR	TYPE: K-118 FLOATING	LENGHT: 11,00 cm WEIGHT: 19,20 gr
	PLASTIC LURE	
	CODE: 05.04.***	
L 11		
L 13		
L 16		
L 21		
L 23		
L 39		
L 41		
L 71		
L 75		
L 82		
L 86		
L 89		
L 91		
L 93		
L 98		

COLOR

TYPE: K-216 4,00 cm • CODE:05.07.\*\*\*

TYPE: K-217 5,50 cm • CODE:05.08.\*\*\*

TOP WATER PLASTIC LURE

- D 12
- L 03
- L 10
- L 11
- L 13
- L 48
- L 99
- L 220
- Y 12



TYPE: WB 8077  
10gr

- L01 CODE: 17.64.001
- L02 CODE: 17.64.002
- L03 CODE: 17.64.003
- L04 CODE: 17.64.004
- L05 CODE: 17.64.005

PLASTIC LURE

- L01
- L02
- L04
- L03
- L05



COLOR

TYPE: K-360 6 cm / 2,8 gr • CODE:05.45.\*\*\*

TYPE: K-361 7 cm / 5,1 gr • CODE:05.46.\*\*\*

TYPE: K-362 9 cm / 11 gr • CODE:05.47.\*\*\*

FLOATING PLASTIC LURE

- L 11
- L 12
- L 13
- L 22
- L 28
- L 65
- L 220
- L 413



TYPE: GO-002 9 cm / 22,6 gr • CODE: 05.53.\*\*\*

TYPE: GO-003 7,5cm / 10,5 gr • CODE: 05.52.\*\*\*

TYPE: GO-004 5 cm / 6,5 gr • CODE: 05.51.\*\*\*

SINKING

PLASTIC LURE

- L 73
- L 78
- L 181
- L 181A
- L 304
- L 337
- P 192



COLOR

TYPE: 10145

LENGHT: 6 cm

SOFT LURE

CODE: 05.54.\*\*\*

L 03



L 04



L 07



L 11



L 12



TYPE: K-228

LENGHT: 5 cm  
WEIGHT: 4 gr

PLASTIC LURE

CODE: 05.09.\*\*\*

L 03



D 12



L 42



TYPE: L 08 & L 12

SOFT LURE

L 12

C 07

17gr  
CODE:17.67.007



L 12

C 02

17gr  
CODE:17.67.002



L 08

C 06

9gr  
CODE:17.65.006

12gr  
CODE:17.66.006



L 08

C 03

9gr  
CODE:17.65.003

12gr  
CODE:17.66.003



COLOR

TYPE: 10172

LENGHT: 13,5 cm

SOFT LURE

CODE: 05.56.\*\*\*

L 03



L 04



L 07



L 11



L 12



TYPE: 10149

LENGHT: 7,5 cm

SOFT LURE

CODE: 05.55.\*\*\*

L 03



L 04



L 07



L 11



L 12

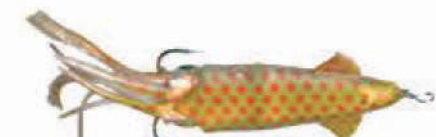

**PLASTIC LURE**

**YB**  
16.5 cm

CODE: 05.48.001



**YELLOW BACK**

**MB**  
16.5 cm

CODE: 05.48.002



**BLACK BACK**

**PB**  
16.5 cm

CODE: 05.48.003



**PURPLE BACK**

**HT**  
20.5 cm

CODE: 05.49.001



**HOT TIGER**

**BB**  
20.5 cm

CODE: 05.49.002



**BLUE BACK**

**RH**  
20.5 cm

CODE: 05.49.003



**RED HEAD**

**PB**  
20.5 cm

CODE: 05.49.004



**PURPLE BACK**

**PLASTIC LURE**

**MB**  
24.0 cm

CODE: 05.63.005



**BLACK BACK**

**BB**  
24.0 cm

CODE: 05.63.003



**BLUE BACK**

**YB**  
24.0 cm

CODE: 05.63.006



**YELLOW BACK**

**RH**  
24.0 cm

CODE: 05.63.001



**RED HEAD**

**PB**  
24.0 cm

CODE: 05.63.004



**PURPLE BACK**

**HT**  
24.0 cm

CODE: 05.63.002



**HOT TIGER**

**PLASTIC LURE**

MB  
22.0 cm

CODE: 05.64.005



**BLACK BACK**

BB  
22.0 cm

CODE: 05.64.003



**BLUE BACK**

RH  
22.0 cm

CODE: 05.64.001



**RED HEAD**

YB  
22.0 cm

CODE: 05.64.006



**YELLOW BACK**

PB  
22.0 cm

CODE: 05.64.004



**PURPLE BACK**

HT  
22.0 cm

CODE: 05.64.002



**HOT TIGER**

**PLASTIC LURE**

10142 - 16,5 cm CODE: 05.50.001  
10141 - 22,0 cm CODE: 05.50.002



**TYPE: GO-023 FLOATING  
LENGHT: 9 cm - WEIGHT: 7 gr**

CODE: 05.28.\*\*\*

L501



L220



L09N



L10



L04N



**TYPE: GO-083 TOP WATER POPPER  
LENGHT: 6,5 cm - WEIGHT: 12 gr**

CODE: 05.27.\*\*\*

L220



L04N



L202



L22N



Y10N

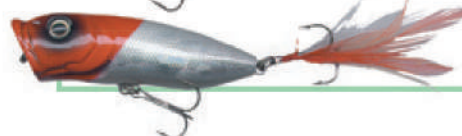

# SQUID JIG

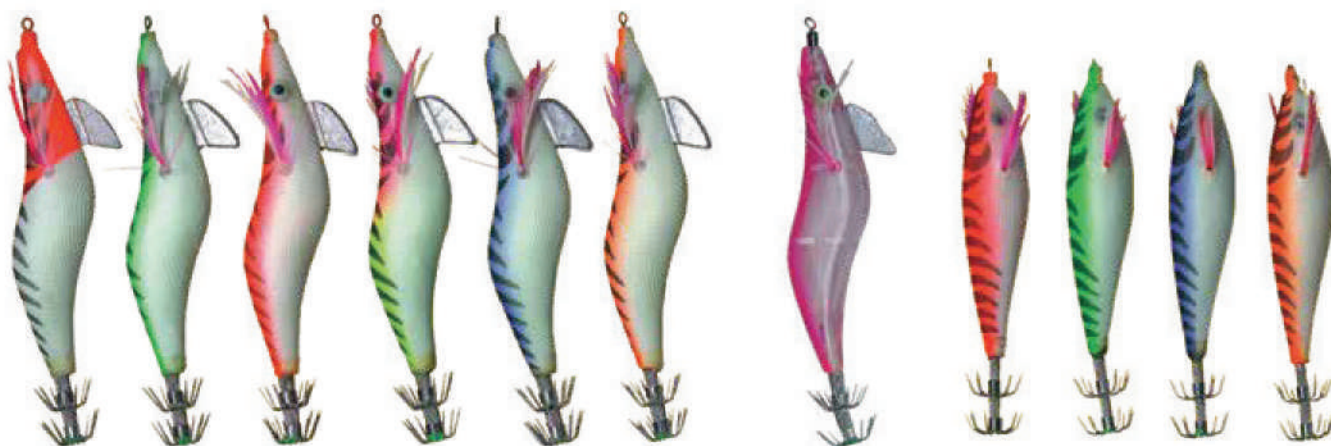

SIZE 1,5 - CODE: 17.05.\*\*\* SIZE 3,0 - CODE: 17.07.\*\*\*  
 SIZE 2,5 - CODE: 17.06.\*\*\* SIZE 3,5 - CODE: 17.28.\*\*\*

SIZE 2,5 - CODE: 17.19.\*\*\*  
 SIZE 3,0 - CODE: 17.20.\*\*\*

7 cm - CODE: 17.08.\*\*\*



L05

L06

L07

L09

L12

SIZE 3,0 - CODE: 17.56.\*\*\*  
 SIZE 3,5 - CODE: 17.57.\*\*\*

## SILICONE

PINK BROWN ORANGE LUMINOUS



CODE: 17.25.\*\*\*

# SQUID JIG

CODE: 17.27.\*\*\*



L05 L06 L07 L08 L09



CODE: 17.49.001  
CODE: 17.49.002  
CODE: 17.49.003  
CODE: 17.49.007  
COLOR: L-01 COLOR: L-02 COLOR: L-03 COLOR: L-07

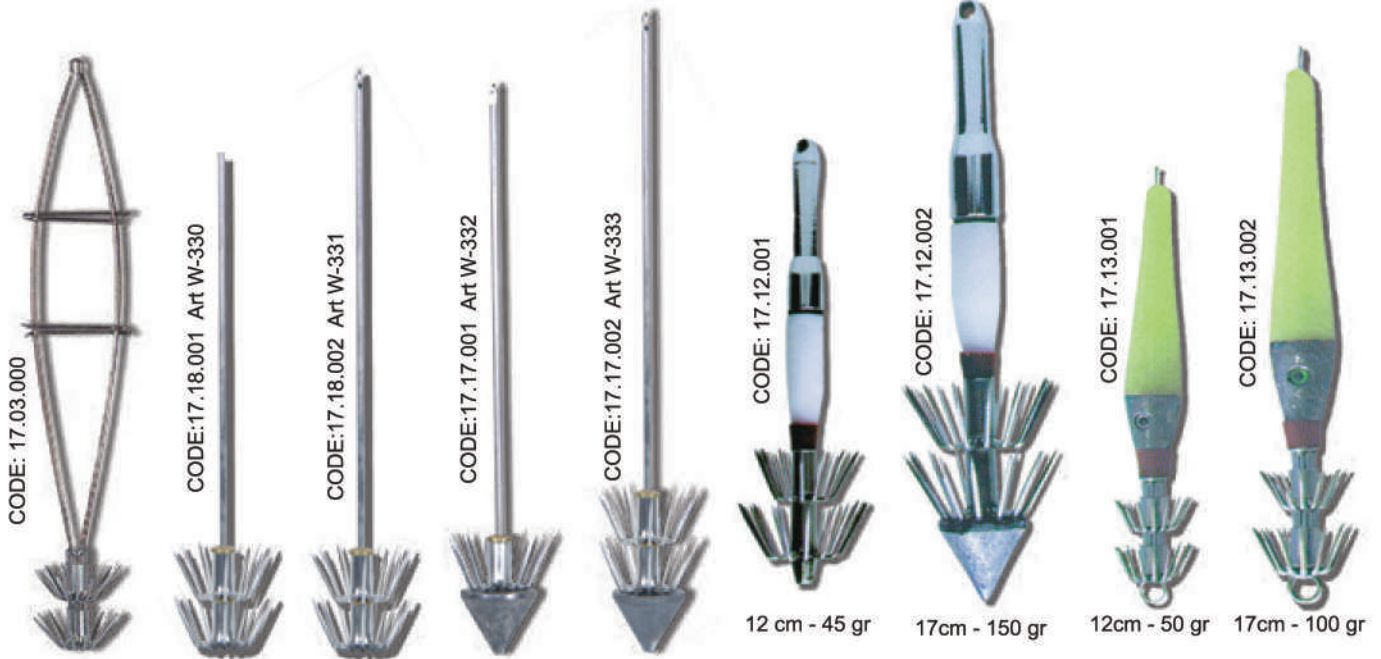

CODE: 17.03.000

CODE:17.18.001 Art W-330

CODE:17.18.002 Art W-331

CODE:17.17.001 Art W-332

CODE:17.17.002 Art W-333

CODE: 17.12.001

CODE: 17.12.002

CODE: 17.13.001

CODE: 17.13.002

12 cm - 45 gr

17cm - 150 gr

12cm - 50 gr

17cm - 100 gr

W-10

W-11

W-12

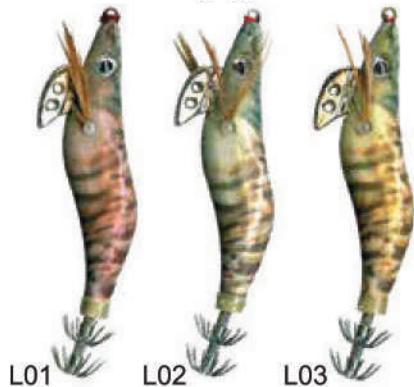

L01 L02 L03  
W-10-2.5 CODE: 17.40.\*\*\*  
W-10-3.0 CODE: 17.41.\*\*\*  
W-10-3.5 CODE: 17.42.\*\*\*

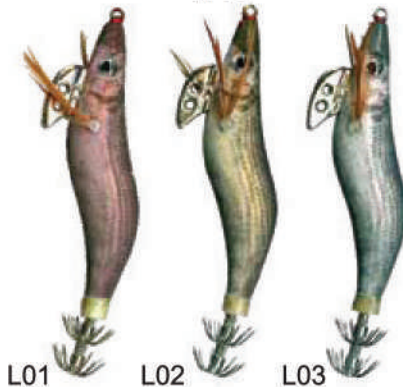

L01 L02 L03  
W-11-2.5 CODE: 17.43.\*\*\*  
W-11-3.0 CODE: 17.44.\*\*\*  
W-11-3.5 CODE: 17.45.\*\*\*

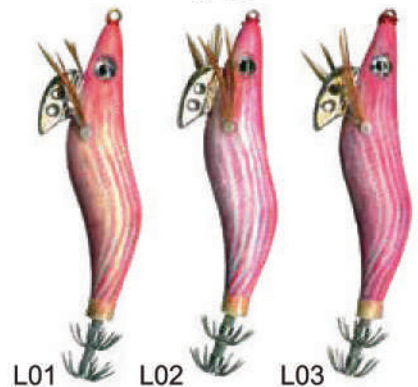

L01 L02 L03  
W-12-2.5 CODE: 17.46.\*\*\*  
W-12-3.0 CODE: 17.47.\*\*\*  
W-12-3.5 CODE: 17.48.\*\*\*

# JIG-ACCESORIES



GLOW 001



ORANGE 003



PINK 002

RB 27 (80gr) CODE: 17.68.\*\*\*  
 RB 27 (100gr) CODE: 17.69.\*\*\*



## SKIRT (2 PCS/BAG)



L 01  
17.76.001



L 02  
17.76.002



L 03  
17.76.003



L 04  
17.76.004



L 05  
17.76.005



L 06  
17.76.006



L 01  
17.86.001



L 04  
17.86.004



L 02  
17.86.002



L 03  
17.86.003



PINK/GOLD  
004



RED/GOLD  
003



ORANGE/GOLD  
002



GREEN/GOLD  
001

ULU-023 (60gr) CODE: 17.82.\*\*\*  
 ULU-024 (80gr) CODE: 17.83.\*\*\*  
 ULU-025 (100gr) CODE: 17.84.\*\*\*  
 ULU-026 (120gr) CODE: 17.85.\*\*\*

**KABURA ART- W-2009**

40 gr CODE: 05.75.\*\*\*

80 gr CODE: 05.76.\*\*\*

120 gr CODE: 05.77.\*\*\*



L105



L113



L203



L110



L303



L111

**SOFT SQUID RIG**

YELLOW  
CODE: 17.29.001



LUMINOUS  
CODE: 17.29.002



BLUE/WHITE  
CODE: 17.29.003



ORANGE/WHITE  
CODE: 17.29.004



# JIG-ACCESORIES

UV-YELLOW  
001



UV-PINK  
003



UV-RED  
002



UV-ORANGE  
004



BACK  
SIDE



LF 143 (40gr) CODE: 17.78.\*\*\* LF 143 (80gr) CODE: 17.80.\*\*\*  
 LF 143 (60gr) CODE: 17.79.\*\*\* LF 143 (100gr) CODE: 17.81.\*\*\*

LF 158 / L 09



LF 158 / L 08



LF 158 / L 05



LF 158 / L 11



LF 158 / L 06



CODE: 17.75.\*\*\*



No 1



No 1/0



No 2/0



No 3/0



No 4/0



No 5/0



No 6/0

LF 158 / L 10



LF 158 / L 16



LF 158 (40gr) CODE: 17.60.\*\*\* LF 158 (60gr) CODE: 17.61.\*\*\*  
 LF 158 (80gr) CODE: 17.62.\*\*\* LF 158 (100gr) CODE: 17.63.\*\*\*

JIG

ART W-2004



	cm	gr
CODE: 05.71.***	22	200
CODE: 05.72.***	26	300

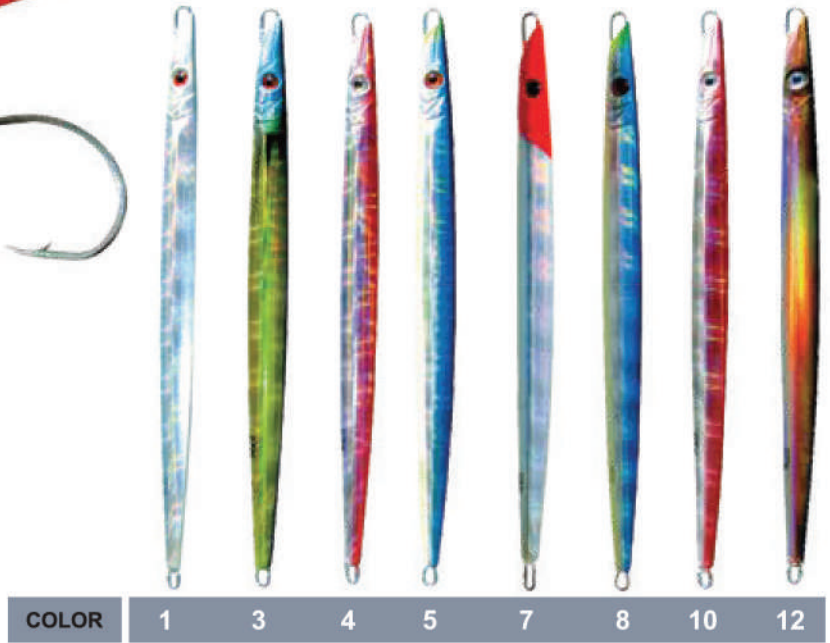

COLOR 1 3 4 5 7 8 10 12

ART W-2007



	cm	gr
CODE: 05.66.***	17	150
CODE: 05.67.***	21	200
CODE: 05.68.***	22,5	250
CODE: 05.69.***	24	300
CODE: 05.70.***	25	350



COLOR 1 4 5 6 7 9 10 12 13

# OCTOPUS JIG

CODE: 17.02.001



CODE: 17.02.002



CODE: 17.02.003



CODE: 17.09.000

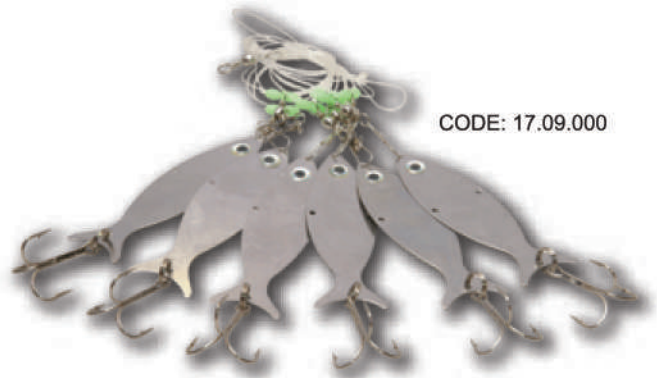

CODE: 17.09.001

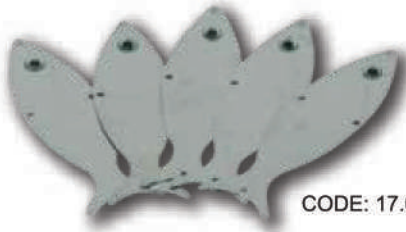

CODE: 17.10.\*\*\*



WHITE



PINK



LUMINOUS

SPARE CRAB  
CODE: 17.04.001



SIZE M

SIZE M - CODE: 17.00.\*\*\*    SIZE L - CODE: 17.01.\*\*\*



WHITE



PINK



LUMINOUS

SPARE CRAB  
CODE: 17.04.002



SIZE L

# SPINNER



## SP 05

SIZE	1	2	3	4	5
WEIGHT (gr)	3,5	5,5	8,2	13,0	18,5
LENGTH (cm)	5,0	5,6	6,5	7,5	8,3



## SP 08

SIZE	1	2	3	4	5
WEIGHT (gr)	3,6	5,7	8,5	11,8	14,0
LENGTH (cm)	5,5	5,8	6,5	7,4	7,7



## SP 08B

SIZE	1	2	3	4	5	6
WEIGHT (gr)	2,7	4,1	5,6	9,0	15,7	20,0
LENGTH (cm)	5,0	5,4	6,2	7,3	8,3	9,0



## SP 14

SIZE	1	2	3	4	5
WEIGHT (gr)	4,8	6,6	8,7	10,5	13,0
LENGTH (cm)	6,2	6,8	7,3	8,3	9,0

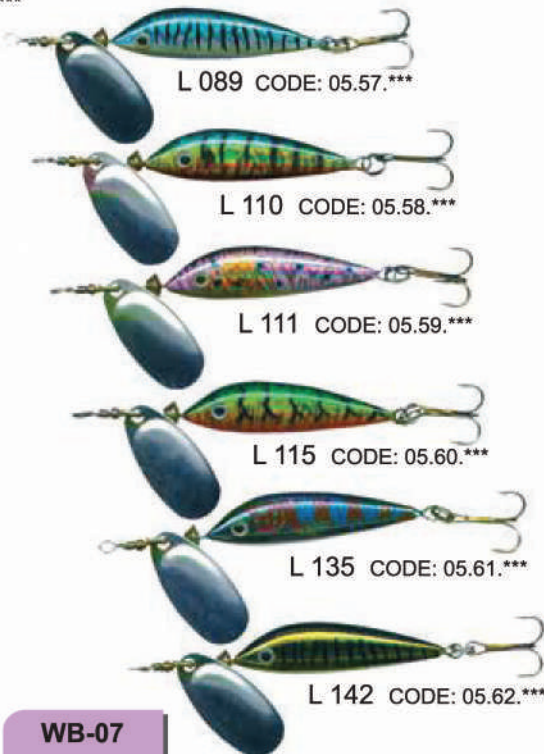

## SP 45

SIZE	1	2	3	4	5	6
WEIGHT (gr)	4,7	5,7	9,3	12,0	16,0	26,5
LENGTH (cm)	9,5	10,5	11,5	11,5	12,0	12,0

## WB-07

SIZE	1	2	3	4
WEIGHT (gr)	8,0	9,7	11,0	12,0

# SPINNER

## SP 01

024 CODE: 11.10.\*\*\* 666 CODE: 11.11.\*\*\* 007 CODE: 11.12.\*\*\*



SIZE	1	2	3	4	5
WEIGHT (gr)	3,0	6,0	8,0	12,0	14,0
LENGTH (cm)	6,0	7,0	7,5	8,0	9,0

## SP 01H

168 CODE: 11.13.\*\*\* 606 CODE: 11.14.\*\*\* 668 CODE: 11.16.\*\*\* 627 CODE: 11.15.\*\*\*



SIZE	4	5
WEIGHT (gr)	18,0	22,0
LENGTH (cm)	16,0	16,5

## SP 02

051 CODE: 11.17.\*\*\* 052 CODE: 11.18.\*\*\* 027 CODE: 11.19.\*\*\* 606 CODE: 11.20.\*\*\* 138 CODE: 11.21.\*\*\*



SIZE	1	2	3	4
WEIGHT (gr)	3,5	6,0	8,0	12,0
LENGTH (cm)	6,0	7,0	7,5	8,0

## SP 02T

051 CODE: 11.22.\*\*\* 052 CODE: 11.23.\*\*\*



SIZE	1/3	2/4	3/5
WEIGHT (gr)	9,0	14,0	17,0
LENGTH (cm)	9,0	10,0	11,0

## SP 08

073 CODE: 11.25.\*\*\* 080 CODE: 11.26.\*\*\* 085 CODE: 11.27.\*\*\* 086 CODE: 11.28.\*\*\*



072 CODE: 11.29.\*\*\* 081 CODE: 11.30.\*\*\* 021 CODE: 11.31.\*\*\* 019 CODE: 11.32.\*\*\*



074 CODE: 11.33.\*\*\* 031 CODE: 11.34.\*\*\*

SIZE	1	2	3	4	5
WEIGHT (gr)	4,0	6,0	10,0	13,0	16,0
LENGTH (cm)	5,5	6,0	6,5	8,0	8,5

## SP 05

033 CODE: 11.24.\*\*\*



SIZE	1	2	3	4	5
WEIGHT (gr)	5,0	7,0	10,0	12,5	15,0
LENGTH (cm)	6,5	7,0	8,0	8,5	9,0

## SPINNER

### SP 10



002  
CODE: 11.35.\*\*\*

SIZE	0	1	2
WEIGHT (gr)	1,5	2,5	3,5
LENGTH (cm)	4,0	4,5	5,5

### SP 12



062 CODE: 11.36.\*\*\*    060 CODE: 11.37.\*\*\*    028 CODE: 11.38.\*\*\*    058 CODE: 11.39.\*\*\*    651 CODE: 11.40.\*\*\*

SIZE	1	2	3	4
WEIGHT (gr)	3	4	6	10
LENGTH (cm)	5,5	6,0	6,5	7,5

### SL 45

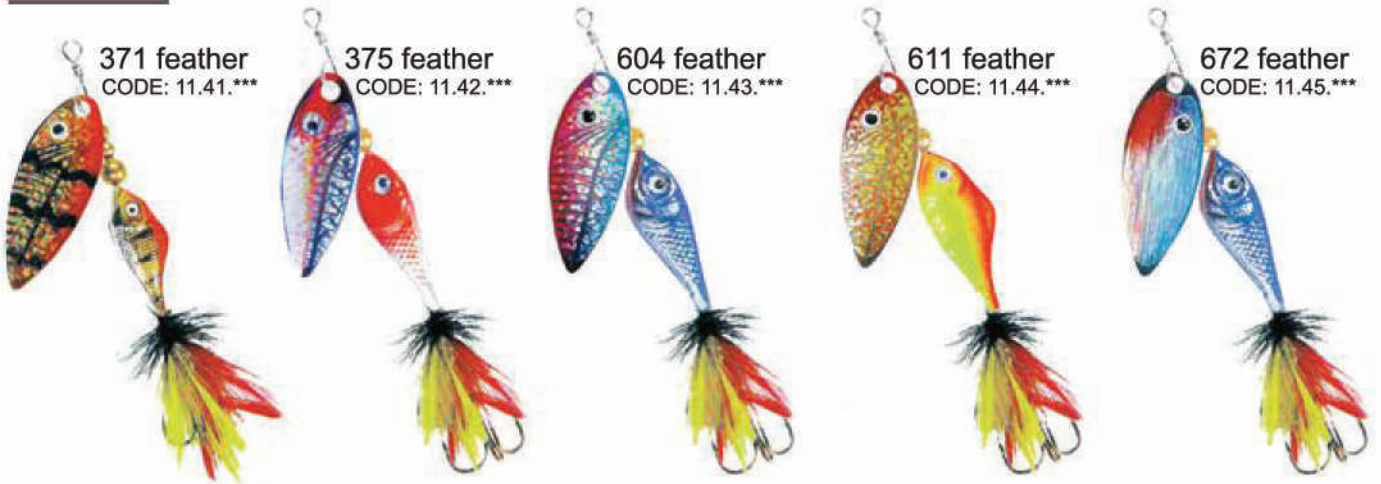

371 feather  
CODE: 11.41.\*\*\*

375 feather  
CODE: 11.42.\*\*\*

604 feather  
CODE: 11.43.\*\*\*

611 feather  
CODE: 11.44.\*\*\*

672 feather  
CODE: 11.45.\*\*\*

SIZE	3	4
WEIGHT (gr)	19,0	25,0
LENGTH (cm)	10,5	11,5

### NP 03

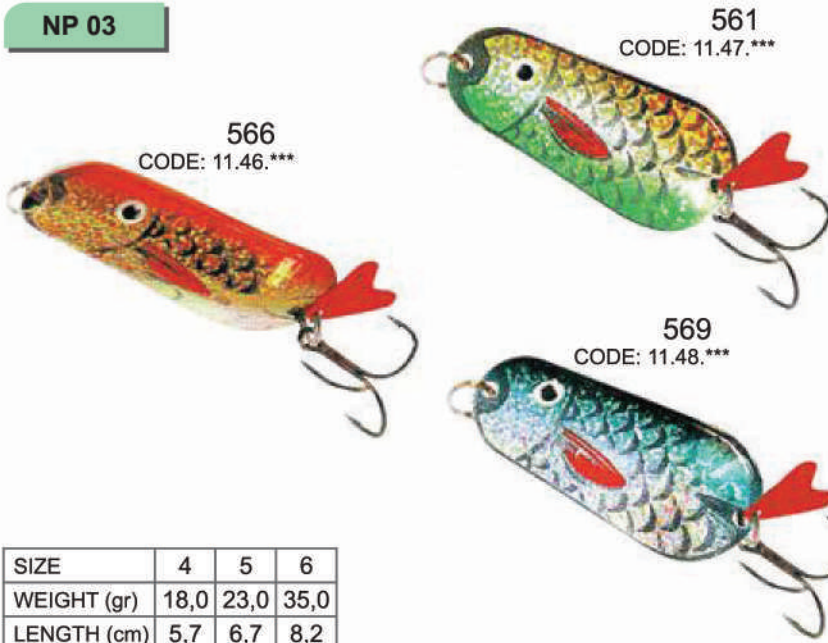

566  
CODE: 11.46.\*\*\*

561  
CODE: 11.47.\*\*\*

569  
CODE: 11.48.\*\*\*

SIZE	4	5	6
WEIGHT (gr)	18,0	23,0	35,0
LENGTH (cm)	5,7	6,7	8,2

### NP 03C



956  
CODE: 11.49.\*\*\*

960  
CODE: 11.50.\*\*\*

SIZE	3	4	5	6
WEIGHT (gr)	15,0	20,0	30,0	40,0
LENGTH (cm)	4,9	5,8	6,5	9,0

# ACCESSORIES

## TUBE FOR FREE SLIDE



CODE: 17.77.001 80 gr  
CODE: 17.77.002 100 gr

## FOAM STOP W-712



CODE: 14.44.001 4 x 15 mm  
CODE: 14.44.002 4 x 18 mm

## CROSS BEADS LUMINOUS



Size: 5x8mm  
Line max: 0.55mm  
Qty: 20pcs  
CODE: 14.21.001 3 x 5 mm  
CODE: 14.21.002 4,5 x 6 mm  
CODE: 14.21.003 5 x 8 mm  
CODE: 14.21.004 7x10 mm

## SLIDING KNOT W-555



CODE: 14.42.000

## MOVING METAL SWIVEL W/SNAP W-444



CODE: 04.15.001 size S  
CODE: 04.15.002 size M

## BAIT CLIP W-443



CODE: 14.08.005

## LED LURE WL-201 L



CODE: 16.34.001 Multicolor

## LED LURE WL-205 S



CODE: 16.35.001 Multicolor

## HARD TUBE FOR RIG 6,7 mm



CODE: 10.15.004

## FOAM FLOAT W/SILICON TUBE W-711



COLOR FLUO/GREEN



COLOR FLUO/ORANGE



COLOR FLUO/YELLOW

CODE: 14.45.\*\*\* size S / CODE: 14.46.\*\*\* size M / CODE: 14.47.\*\*\* size L

# ACCESSORIES

## FLOAT GREEN IN GLOW



SIZE 1 (7,3x15 mm)  
CODE: 14.64.001



SIZE 2 (8,8x18,5 mm)  
CODE: 14.64.002



SIZE 3 (10x21 mm)  
CODE: 14.64.003



SIZE 4 (11,5x26 mm)  
CODE: 14.64.004

## FLOAT FLUO/RED



SIZE 1 (7,3x15 mm)  
CODE: 14.63.001



SIZE 2 (8,8x18,5 mm)  
CODE: 14.63.002



SIZE 3 (10x21 mm)  
CODE: 14.63.003



SIZE 4 (11,5x26 mm)  
CODE: 14.63.004

## FLOAT MULTI COLOR WITH WING



SIZE 1 (9,5x16,5 mm) CODE: 14.60.001

## FLOAT RED/GLOW WITH WING



SIZE 1 (9,5x16,5 mm) CODE: 14.62.001

## FLOAT GREEN/GLOW WITH WING



SIZE 1 (9,5x16,5 mm) CODE: 14.61.001



SIZE 2 (11,5x20 mm) CODE: 14.60.002



SIZE 2 (11,5x20 mm) CODE: 14.62.002



SIZE 2 (11,5x20 mm) CODE: 14.61.002

# ACCESSORIES

## ROUND HARD LUM BEADS



CODE: 14.12.\*\*\* LUMINOUS mm: 3-4-5  
 CODE: 14.13.\*\*\* TRANSPARENT mm: 3-4-5  
 CODE: 14.07.001 LUMINOUS 6 x 8 mm  
 CODE: 14.07.002 LUMINOUS 8 x 10 mm  
 CODE: 14.07.003 LUMINOUS 10 x 14 mm

## SOFT BEADS LUM



CODE: 14.10.001 3,4 x 5 mm  
 CODE: 14.10.002 5 x 8 mm  
 CODE: 14.10.003 6 x 8 mm  
 CODE: 14.10.004 7 x 10 mm  
 CODE: 14.10.005 8 x 12 mm

## SOFT BEADS BLACK



OVAL 5x8 mm  
 ROUND S-6mm  
 ROUND L-8mm  
 CODE: 14.05.000  
 CODE: 14.06.001  
 CODE: 14.06.002

## PATER NOSTER



CODE: 14.20.\*\*\*  
 No: S - M - L - LL

## SILICON STOPER



CODE: 14.17.\*\*\*  
 No: S - M - L - LL

## FOAM STOP



CODE: 14.14.\*\*\*  
 No1: 5,5x11 mm  
 No2: 6,3x13,2 mm  
 No3: 7,3x15 mm  
 No4: 8,8x18,5 mm  
 No5: 10x21 mm  
 No6: 11,5x26 mm  
 No7: 13x32 mm

## FOAM STOP W/PIPE



RED-YELLOW CODE: 14.37.\*\*\*  
 No3: 6,3x13,2 mm  
 No4: 7,3x15 mm  
 No5: 8,8x18,5 mm  
 No6: 10x21 mm  
 No7: 11,5x26 mm  
 No8: 13x32 mm

## FOAM STOP W/PIPE



YELLOW CODE: 14.25.\*\*\*  
 No1: 4,7x10 mm  
 No2: 5,6x11 mm  
 No3: 6,3x13,2 mm  
 No4: 7,3x15 mm  
 No5: 8,8x18,5 mm  
 No6: 10x21 mm  
 No7: 11,5x26 mm  
 No8: 13x32 mm

## RUBBER STOPER



CODE: 14.15.\*\*\*  
 No: SS - S - M - L - LL

## RUBBER STOPER



CODE: 14.24.\*\*\*  
 No: SS - S - M - L - LL

## RUBBER STOPER



CODE: 14.16.\*\*\*  
 No: SS - S - M - L - LL

## LANA



CODE: 14.18.\*\*\*  
 No: SS - S

# ACCESSORIES

**NYLON RIG SET - 2 HOOKS**



CODE: 10.00.\*\*\* BROWN SODE HOOKS  
 CODE: 10.01.\*\*\* NICKEL SODE HOOKS  
 CODE: 10.02.\*\*\* NICKEL CHINU HOOKS  
 No: 1 - 2 - 3 - 4 - 5 - 6 - 7 - 8 - 9 - 10

**NYLON RIG SET - 3 HOOKS**



CODE: 10.03.\*\*\* NICKEL SODE HOOKS  
 No: 1 - 2 - 3 - 4 - 5 - 6 - 7 - 8 - 9 - 10



CODE: 10.08.\*\*\*  
 No: 6 - 7 - 8 - 9

**WIRE RIG SET**



CODE: 10.06.\*\*\* CHINU HOOKS  
 No: 2 - 3 - 4 - 5 - 6 - 7

**NYLON RIG SET**



CODE: 10.04.\*\*\* CHINU HOOKS  
 No: 1 - 2 - 3 - 4 - 5 - 6 - 7 - 8 - 9



CODE: 14.22.\*\*\*

**WIRE RIG SET**



CODE: 10.07.\*\*\* CHINU HOOKS  
 No: 2 - 3 - 4 - 5 - 6

**NYLON RIG SET**



CODE: 10.05.\*\*\* CHINU HOOKS  
 No: 2 - 3 - 4 - 5 - 6 - 7

**STOPER FOR BOILES**

CODE: 14.31.000  
 ART W-240



# ACCESSORIES

**ART. W-246**  
CODE: 14.34.000

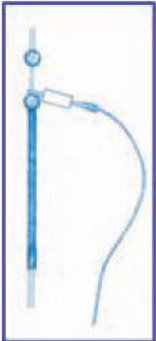

**WITH WEIGHT**  
CODE: 09.62.\*\*\*  
TRANSPARENT - GREEN - ORANGE



CODE: 09.61.\*\*\*

**ART. W-243**  
ΚΩΔ.: 14.08.004

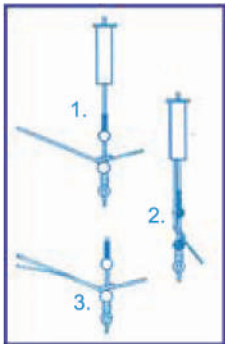

**ART. W-241** CODE: 09.64.001



**BAIT CLIP W-231**  
CODE: 14.08.001



**BAIT CLIP W-230**  
CODE: 14.08.000



**BAIT CLIP**  
CODE: 14.08.002



**ART. W-244**



**BAIT CLIP**  
CODE: 14.08.003  
**ART. W-245**



**SLIDING SWIVEL**  
CODE: 04.36.\*\*\*  
**ART. W-248**



**ART. W-242**  
CODE: 14.32.000



## SWIVEL W/HOOKS SNAP FOR CORKS

**ART. W-237** CODE: 04.19.\*\*\*



**S M L**

**ART. W-238**  
CODE: 04.18.\*\*\*



**1 2**

**ART. W-234**  
CODE: 04.33.\*\*\*

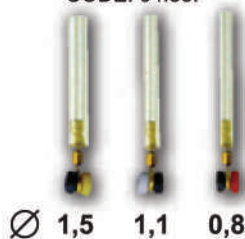

**Ø 1,5 1,1 0,8**



# ACCESSORIES

CODE: 09.60.\*\*\*

No 1

No 2

No 3

CODE: 09.81.001 LUMINOUS NOSE

20x9

**PLASTIC TUBE**  
CODE: 14.00.003



**LUMINOUS SILICON TUBE**  
CODE: 14.28.\*\*\*



100 mm Ø 3 mm

**BLACK SILICON TUBE**  
CODE: 14.27.\*\*\*



Ø 0,8-1,0-1,2-1,6 mm

**NATURAL SILICON TUBE**  
CODE: 14.09.\*\*\*



Ø 0,3-0,6-0,7-1,0-1,2  
1,6-1,8-2,0 mm

**SURF CASTING RIG**



CODE: 10.14.000  
2 HOOKS

CODE: 10.14.001  
SUSSY

**SUSSY**

CODE: 14.00.001 **BLACK / MINI**  
CODE: 14.00.002 **YELLOW / MINI**  
CODE: 14.00.004 **BLACK / LONG**  
CODE: 14.00.005 **YELLOW / LONG**



**CROSS BEADS**

CODE: 14.11.\*\*\*



2 x 3  
3 x 5  
4,5 x 6  
5 x 8  
7 x 10

**SINGLE WIRE CONNECTIONS**

CODE: 15.21.\*\*\*

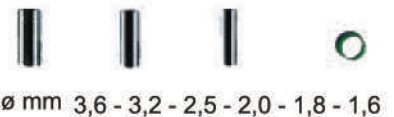

Ø mm 3,6 - 3,2 - 2,5 - 2,0 - 1,8 - 1,6

**DOUBLE WIRE CONNECTIONS**

CODE: 15.22.\*\*\*

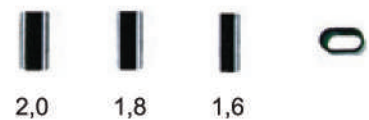

2,0 1,8 1,6

**ALUMINUM WIRE CONNECTIONS**

CODE: 15.27.\*\*\*



A. 1.0 x 2.0 x 10 mm  
B. 1.2 x 2.4 x 10 mm  
C. 1.4 x 2.8 x 10 mm  
D. 1.6 x 3.2 x 10 mm  
E. 1.8 x 3.6 x 18 mm  
F. 2.0 x 4.0 x 18 mm

# ACCESSORIES

**SALVANOTI**  
CODE: 09.63.\*\*\*



SIZE: 4 mm - 6 mm

CODE: 14.19.\*\*\*



No S M L

**RIG SET**  
CODE: 10.09.001



10 HOOKS

**NYLON COATED WIRE**  
CODE: 15.20.\*\*\*



5 lbs 10 lbs 15 lbs 20 lbs  
30 lbs 40 lbs 50 lbs 60 lbs

**ART. W-442**  
CODE: 10.21.000



**NYLON RIG**  
CODE: 10.09.000



10 HOOKS

**WIRE RIG**  
CODE: 15.28.\*\*\*



15 cm 7 kgr  
23 cm 10 kgr  
30 cm 13 kgr

**ELECTRONIC SCALE**  
CODE: 12.46.000



**ART. W-441**  
CODE: 14.31.001



**WIRE RIG**  
CODE: 10.12.\*\*\*



5 HOOKS - 10 HOOKS  
20 HOOKS

**ART. W-027**  
ΚΩΔ.: 14.26.000



CODE: 14.35.001



**APT. W-270**



CODE: 04.37.001 SIZE S  
CODE: 04.37.002 SIZE L

**BOOM W-271**  
CODE: 14.36.001



# ACCESSORIES

## FISHING BELLS



CODE: 16.13.000  
DOUBLE



CODE: 16.10.000  
SINGLE



CODE: 16.10.001  
DOUBLE



ART. W-705  
ΚΩΔ.: 16.32.001



CODE: 16.11.001  
DOUBLE



CODE: 16.11.000  
SINGLE



CODE: 16.12.001  
DOUBLE



CODE: 16.12.000  
SINGLE

## SPOON CODE: 11.01.\*\*\*



## SPOON CODE: 11.00.\*\*\*



## DIVING BOARD CODE: 16.04.000

50 gr



WHITE



BLACK

## NET FOLD FISH TRAP

CODE: 12.18.\*\*\*



- No 1
- No 2
- No 3
- No 4

# ACCESSORIES

## HOOK DISGORGER

CODE: 16.05.652    CODE: 16.05.648    CODE: 16.05.649    CODE: 16.05.651    CODE: 16.05.003    CODE: 16.05.296



Art 652    Art 648    Art 649    Art 651    Art 296

**ART. W-103**  
CODE: 16.33.001



**COLORS**  
RED  
BLUE  
GREEN

## SPARKS

**W-513**  
CODE: 16.08.001  
**COLORS**  
RED  
MULTICOLOR  
GREEN



**ART. W-510**  
CODE: 16.18.\*\*\*



(1 BATTERY)

**COLORS**  
RED  
BLUE  
GREEN  
TRANSPARENT

**ART. W-511**  
CODE: 16.19.\*\*\*



(2 BATTERIES)

## FEEDER

CODE: 15.34.\*\*\*    Art SH580    CODE: 15.35.000

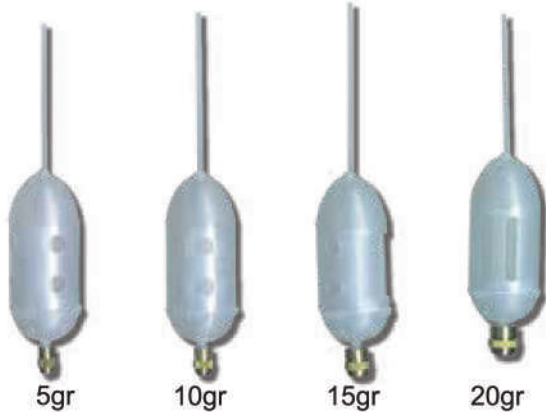

5gr    10gr    15gr    20gr



CODE: 15.42.\*\*\*    CODE: 15.43.\*\*\*

20 gr  
30 gr  
40 gr  
50 gr  
60 gr  
70 gr  
100 gr

## BAIT SPRING

CODE: 15.45.001    CODE: 15.44.\*\*\*



6cm    15 gr / 20 gr / 30 gr / 40 gr

CODE: 15.36.\*\*\*  
SH 571

7gr  
10gr



CODE: 15.31.\*\*\*

P1 20gr    P2 40gr

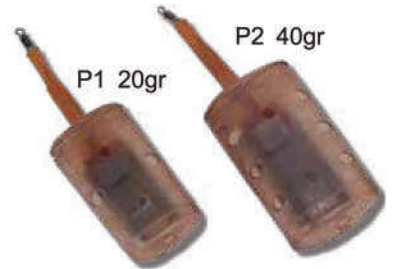

CODE: 15.32.\*\*\*



S1 15gr    S2 30gr

## BAIT SPRING WITH 30 cm TUBE

CODE: 15.37.000

## HARD TUBE

CODE: 15.38.000

## BAIT SPRING WITH 30 cm TUBE

CODE: 15.37.001

# ACCESSORIES

## SAND ROD POD



90 cm  
CODE: 15.12.090

120 cm  
CODE: 15.12.120

## ROD PODS



ROD POD FOR BOA  
CODE: 15.04.001



LENGTH  
Ø 4,5 cm



SAND ROD POD  
CODE: 15.00.001

LENGTH 46 cm  
Ø 4,5 cm

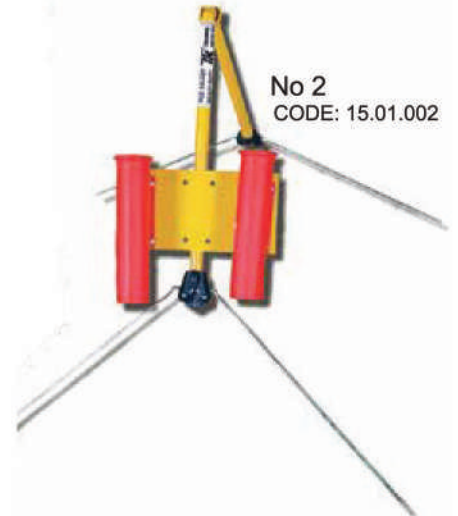

No 2  
CODE: 15.01.002

## HORIZONTAL ROD POD

CODE: 15.03.001 CODE: 323 3 SEATS



LENGTH: 78-125 cm  
HEIGHT: 50-58 cm

CODE: 15.03.002 CODE: 321 1 SEAT



SAND ROD POD  
CODE: 15.00.006

HBO-112  
OPEN: 110 cm  
CLOSED: 62 cm

ROD CAP  
CODE: 15.40.000



ADAPTER HG-003  
CODE: 15.00.008



XX-001

CODE: 15.00.007V CODE: 15.00.007U



## ACCESSORIES

**SURF CASTING ROD POD**  
CODE: 15.02.003



HEIGHT OPEN: 1,80 cm  
HEIGHT CLOSED: 1,20 cm

**SURF CASTING ROD POD**  
CODE: 15.02.001



HEIGHT OPEN: 1,20 cm  
HEIGHT CLOSED: 0,60 cm

**CHAIRS WITH BAGS  
& ROD PODS**  
Art 79  
CODE: 15.10.002



**CHAIRS WITH  
ROD PODS**  
Art 19  
CODE: 15.10.001



**CHAIRS**  
Art LT 003  
CODE: 15.10.004



# ACCESSORIES

## ROD BELTS

CODE: 14.30.003  
Art 568



CODE: 14.30.002  
Art 324



CODE: 14.30.000  
Art 507



CODE: 14.30.001  
Art 265



**HOOB BINDING MACHINE**  
Art 0100383  
CODE: 15.08.000



**BAIT BUCKET PVC**  
CODE: 13.09.000



**MIXING BAIT BAG**  
CODE: 13.41.000



**ROD STRAP**  
CODE: 15.41.000



**WATER BUCKET**  
CODE: 15.14.001



**SET STRAP FOR RODS W-445**  
CODE: 15.18.001



3x30 cm



3x20 cm

# ACCESSORIES

## REEL PROTECTION BAGS



- No 1** (L) 19 cm x (W) 7 cm x (H) 15 cm    CODE: 13.42.001  
**No 2** (L) 22 cm x (W) 12 cm x (H) 23 cm    CODE: 13.42.002

## KNIFE

### Art FK-05

- CODE: 17.37.001  
 CODE: 17.37.000 (BOX 24 PCS)



## W-770

CODE: 13.45.000



## PLIERS

Art PL-45 (4,5''  
 CODE: 16.24.003

## W-760

CODE: 13.45.001



## LIVER-REPLACEMENT NET

CODE: 12.33.000

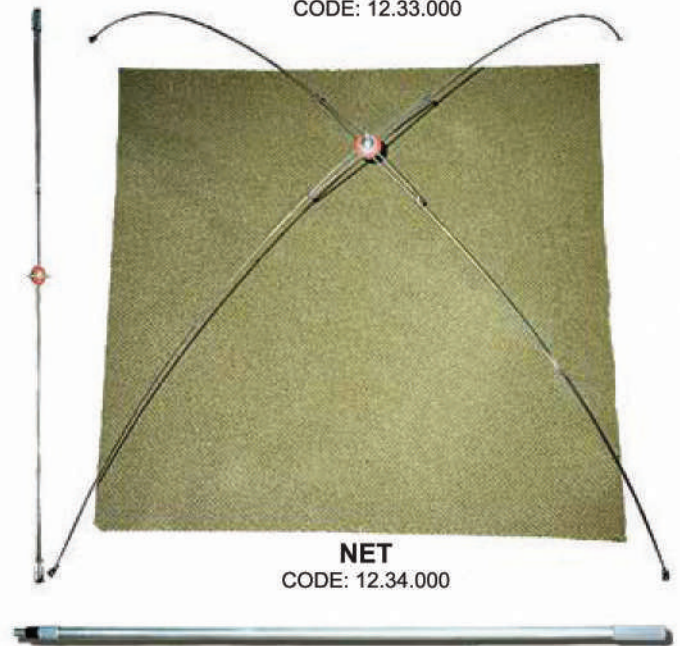

## NET

CODE: 12.34.000

CODE: 12.28.013    3x150 cm

# ACCESSORIES

**LUMINOUS CROSS FOR RIG**



CODE: 10.15.003

**ELASTIC LINE 200 m**



PJ-1 (0,10 mm)  
CODE: 14.43.001

PJ-2 (0,15 mm)  
CODE: 14.43.002



PJ-4(0,25 mm)  
CODE: 14.43.004

**LIGHT STICK 4,5x39 mm**



BAG: 2 Pcs  
CODE: 16.37.001

**LIGHT STICK 10x150 mm**



CODE: 16.38.001

**ANTI-SENSITIVE GLOVES**  
CODE: 15.17.001



**FISH GRIP TOOL**  
CODE: 17.39.001

**FISH GRIP WFG-19**  
CODE: 14.56.\*\*\*



**FISH GRIP WFG-25**  
CODE: 14.55.\*\*\*



# ACCESSORIES

## SPLIT SINKERS SET

CODE: 08.13.001 120gr 6 separations  
 CODE: 08.13.002 120gr 7 separations



CODE: 08.14.\*\*\*

## FLOAT FOR LONG LINE BASINS

CODE: 12.12.\*\*\*

- No 1 15 x 18 x 140 cm
- No 2 13 x 23 x 140 cm
- No 3 18 x 23 x 140 cm



0,100 gr - 0,200 gr  
 0,250 gr - 0,300 gr  
 0,400 gr - 0,500 gr  
 0,800 gr - 1,000 gr

## LONG LINE

CODE: 12.06.\*\*\*



HOOKS  
 50 100 150 200 250 300

## LONG LINE BASIN

W/O FLOAT CODE: 12.10.\*\*\*

W/FLOAT CODE: 12.11.\*\*\*



No: 1 - 2 - 2D - 3 - 4 - 5

## NYLON (1000 m)



WINNER HANK CODE: 02.80.\*\*\*

mm	0.50	0.60	0.70	0.80	0.90	1.00	1.20	1.50	1.80	2.00
Test/Kg	12.70	17.10	21.15	28.00	31.85	41.62	55.00	68.00	78.00	85.00

WINNER "EXTRA" HANK CODE: 02.81.\*\*\*

mm	0.30	0.35	0.40	0.45	0.50	0.60	0.70	0.80	0.90	1.00
Test/Kg	6.78	8.53	11.02	14.20	16.20	21.00	26.31	34.25	39.20	50.82

## FISHING LINE W/HOOK ON WHEEL

LINE 100 m  
 CODE: 12.03.\*\*\*

LINE 100 m  
 CODE: 12.04.\*\*\*

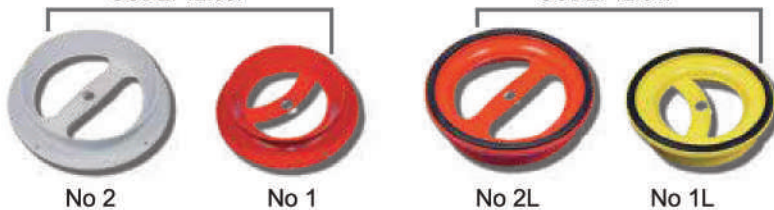

## WHEEL

CODE: 12.00.\*\*\*



No 2 17,5 x 3,5 cm  
 No 1 15 x 3,5 cm

## WHEEL

CODE: 12.01.\*\*\*

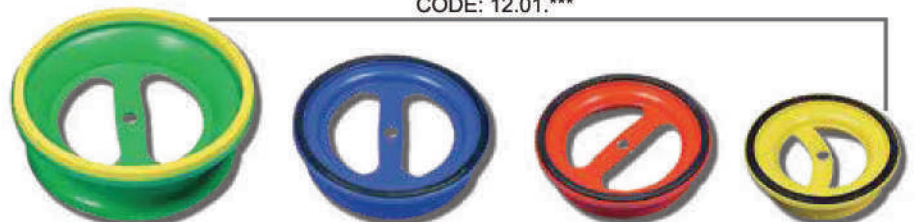

No 4 22 x 7 cm  
 No 3L 21 x 5 cm  
 No 2L 17,5 x 3,5 cm  
 No 1L 15 x 3,5 cm

# ACCESSORIES

## DOUBLE SLIDED BOX

CODE: 13.12.000  
ART 160

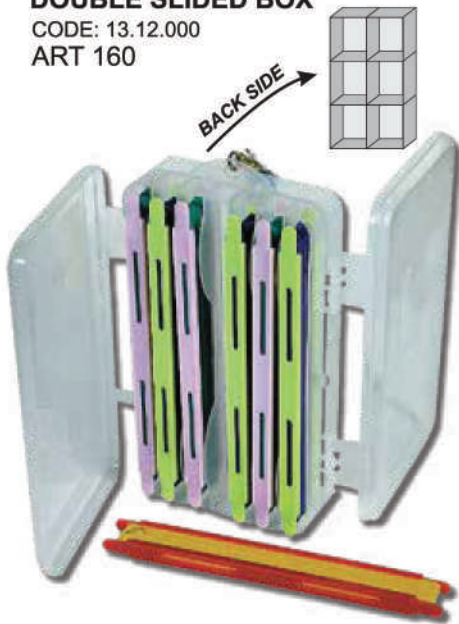

## ROUND CASE

CODE: 13.13.002    CODE: 13.13.001



No 2  
Ø 70 mm

No 1  
Ø 55 mm

## WIRE BASKET

CODE: 12.15.\*\*\*



No	1	2	3
cm	25	30	38

## HOOK BOXES

CODE: 13.17.000    CODE: 13.17.001



## SCALE FOR RINGS

CODE: 13.20.\*\*\*



14 cm  
18 cm  
20 cm  
27 cm

## POUCH RIGGING ON ROD

CODE: 14.58.\*\*\*

2,7 - 3,6 - 4,5 - 5,4 - 6,3



## GLUE FOR ROD RINGS

CODE: 01.00.451



## RIG SET HOLDERS

CODE: 13.12.001    16 PCS  
CODE: 13.12.002    8 PCS



EVA BOARD 14,5x5,5x1cm  
CODE: 14.57.\*\*\*



# ACCESSORIES

## FLOATS FOR RING



CODE: 12.08.000  
Ø 10 x 2,8 cm  
3 PCS



CODE: 12.09.002  
Ø 6 x 1,2 cm



CODE: 12.09.001  
Ø 4 x 1,1 cm



CODE: 16.21.001  
ART. YH 020

## SCISSORS



CODE: 16.20.000  
ART. AH 003

## SCISSORS



CODE: 16.20.017  
WS-236  
4"-12cm

## SCISSORS WITH HOOK SHARPENER



CODE: 16.23.001  
CODE: 16.23.000 (BOX 32 PCS)



CODE: 16.20.004  
WS-116  
PLASTIC



CODE: 16.20.005  
METAL



CODE: 16.20.002  
XH-3S



TC-100 CODE: 16.20.013  
PLASTIC

CODE: 16.21.002  
ART. 254B



CARP RIG  
CODE: 10.22.\*\*\*

No 1/0  
No 1  
No 2  
No 3  
No 4



FOAM FLOAT  
CODE: 18.00.\*\*\*

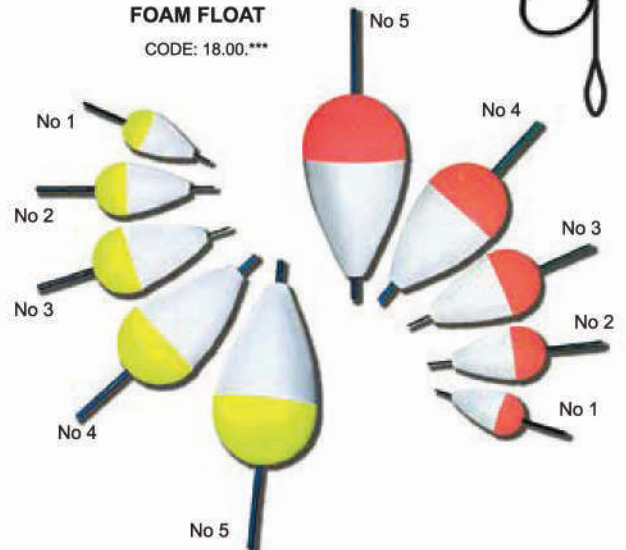

## SLING



PLASTIC  
Art 463  
CODE: 09.23.463



PLASTIC  
W-087  
CODE: 09.23.087

No 1	No 2	No 3	No 4
22,5 x 35	23,5 x 40	25 x 45	28 x 50
No 5	No 6	No 7	No 8
32,5 x 55	37 x 65	46 x 80	58 x 100

# ACCESSORIES







**RIG SETS**  
CODE: 10.15.001



**RIG SETS**  
CODE: 10.15.002

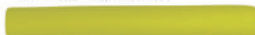

**FLOTTERINI**  
Art - 283

-  WHITE  
CODE: 14.38.001
-  RED  
CODE: 14.38.002
-  YELLOW  
CODE: 14.38.003
-  LUMINUS  
CODE: 14.38.004
-  LUMINUS BLUE  
CODE: 14.38.005
-  LUMINUS RED

**PROTECTIVE FINGER**  
NEOPREN W-538  
CODE: 15.07.002



**PROTECTIVE FINGER**  
CODE: 15.07.001



**RINGS**



**SOLID CODE: 14.50.\*\*\***

Size	XL	L	M	S
Ø	8mm	7mm	6mm	5mm

**SPLIT CODE: 14.53.\*\*\***

Size	4,5x0,8	5x0,9	6x1,2	7x1,4
------	---------	-------	-------	-------

**LUMINUS RED**  
CODE: 14.38.006

**WATER DEPTH**  
CODE: 09.56.\*\*\*

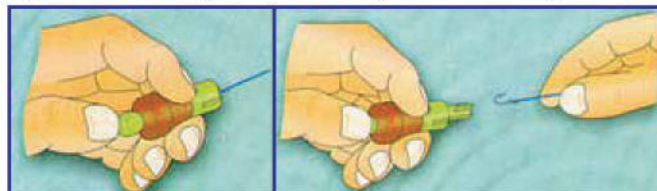
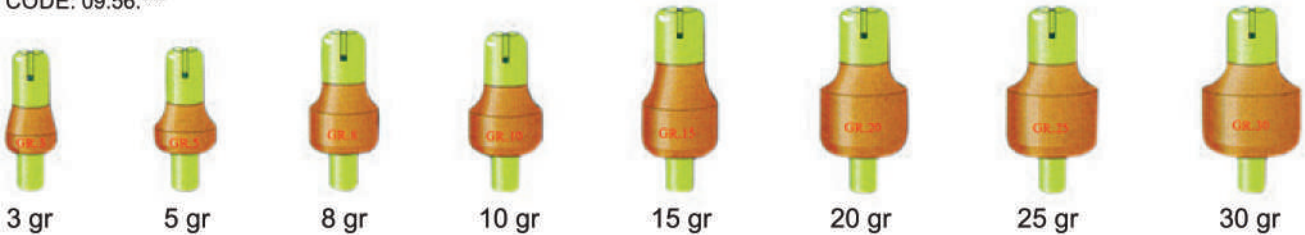

## HEAD LAMPS



CODE: 16.00.001  
CODE. 287  
3 LED



CODE: 16.00.002  
CODE. 288  
5 LED



CODE: 16.00.006  
CODE. 395  
6 LED + 1 LAMP



CODE: 16.00.005  
CODE. 408  
3 LED + 1 LAMP



CODE: 16.00.007  
CODE. 393A  
3 LED + 1 LAMP

## BAGS

(L) 46 cm x (W) 25 cm x (H) 38 cm  
CODE: 13.18.000



(L) 60 cm x (W) 17 cm x (H) 27 cm  
CODE: 13.18.001



### PLASTIC LURE BAG

#### RIG BAG

(L) 24 cm x (W) 5 cm x (H) 22 cm  
CODE: 13.19.000



(L) 37 cm x (W) 16 cm x (H) 24 cm  
CODE: 13.18.002



### JIG BAGS

(L) 41 cm x (W) 8 cm x (H) 26 cm  
CODE: 13.18.003



# BAIT

**BLOOD POWDER (500 gr)**  
CODE: 07.14.007



**AMINO-ACID FOR BOILES (50 gr)**  
NEUTRAL TASTE  
CODE: 07.13.001



**BAG FOR MAGGOTS**  
CODE: 13.27.001



**FEROMON SPRAY (20 ml)**  
CODE: 07.28.001



**GLUE FOR MAGGOTS**  
CODE: 07.07.001 SARDINE  
CODE: 07.07.002 CHEESE



**LIQUID CROUND BAIT (250 cc)**  
CODE: 07.05.\*\*\*

TASTES:  
BLOOD  
SHRIMP  
CHEESE  
SARDINE  
URCHIN  
GARLIC  
HERRING  
250 cc



**DOUGH**  
CODE: 07.18.\*\*\*



TASTES:  
CHEESE      MAGNIME  
SARDINE      SHRIMP

**AMINO-ACID SPRAY (60 cc)**  
CODE: 07.04.\*\*\*



TASTES:  
BLOOD      GARLIC      FISH      CHEESE  
SHRIMP      SARDINE      ANCHOVY      URCHIN  
HERRING      COD

**GUSTO PIU**  
CODE: 07.27.\*\*\*



TASTES:  
PLASMA      URCHIN      GARLIC  
SARDINE      CHEESE      SHRIMP

# BAIT

## NEEDLE FOR BOILES

CODE: 09.70.001



## DRILL FOR BOILES

CODE: 09.70.002



## FLOUR FOR MAGGOTS

CODE: 07.19.001



## POWDER GROUND BAIT (1kg)

CODE: 07.03.\*\*\*



## MASS GROUND BAIT (1kg)

CODE: 07.00.\*\*\*



### TASTES:

CHEESE-GARLIC-SARDINE  
BREAM  
CHEESE  
SARDINE-HERRING  
CHEESE-GARLIC  
CHEESE-SARIMP  
MULLET-BREAM  
URCHIN-CHEESE-AMINOACID  
SARDINE-HERRING-CHEESE-GARLIC  
CHEESE-MILK-GARLIC  
URCHIN-SARDINE-BLOOD  
CRAB-MUSSEL-AMINOACID

## SEMI-WET GROUND BAIT (1,5 kg)

CODE: 07.08.\*\*\*



### TASTES:

CHEESE-GARLIC-SARDINE  
CHEESE  
SARDINE-HERRING  
CHEESE-GARLIC  
CHEESE-SARIMP  
SARDINE-HERRING-CHEESE-GARLIC  
SARDINE-HERRING-GARLIC  
SARDINE-HERRING-CHEESE  
SARDINE  
SARDINE-HERRING-BLOOD  
URCHIN-BLOOD-AMINOACID  
URCHIN-CHEESE-GARLIC-BLOOD  
URCHIN-CHEESE-GARLIC

## MASS GROUND BAIT (3 kg)

CODE: 07.01.\*\*\*



### TASTES:

SARDINE  
SARDINE-HERRING  
SARDINE-BLOOD  
HERRING

## SARDINE OIL

0,5 Kgr

CODE: 07.07.003



# LANDING NETS

**ALUMINIUM WITH INOX SCREW**  
CODE: 12.20.\*\*\*



No 1 Ø 40 cm      No 2 Ø 47 cm      No 3 Ø 44 x 50 cm  
No 4 Ø 52 x 60 cm

**ALUMINIUM POLE WITH INOX SCREW**  
CODE: 12.28.\*\*\*



SIZE (cm): 2x40 - 2x60 - 2x80 - 2x100 - 3x100 - 3x150

**ALUMINIUM NYLON NET**

CODE: 12.30.010

CODE: 12.30.011



Ø 48cm  
21mm



Ø 48cm  
6mm

POLE 2x125 cm

CODE: 12.28.008



**TELESCOPIC ALUMINIUM**  
CODE: 12.21.\*\*\*

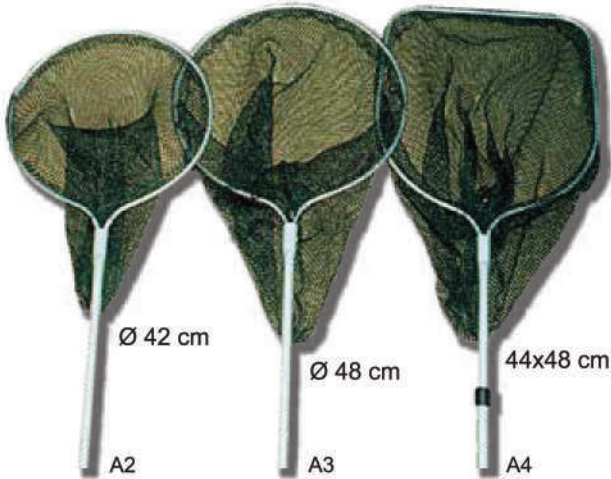

Ø 42 cm

A2

Ø 48 cm

A3

44x48 cm

A4

POLE: 2 x 80 cm

**NYLON NET**  
KQΔ.: 12.30.013

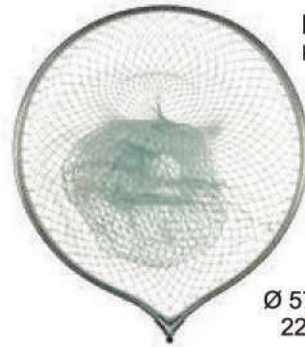

Ø 57cm  
22mm

**NYLON NET**  
CODE: 12.30.014



Ø 57cm  
22mm



CODE: 12.28.009

POLE:  
2x125 cm



CLOSED

CODE: 12.22.001 2x40 cm  
CODE: 12.22.002 2x60 cm  
CODE: 12.22.003 2x80 cm  
CODE: 12.22.004 2x100 cm

# LANDING NETS



CODE: 12.30.002

TELESCOPIC  
ALUMINIUM  
3 PCS  
2,5 m

CODE: 12.30.001

TELESCOPIC  
ALUMINIUM  
2 PCS  
2 m

PLASTIC



CODE: 12.30.003

TELESCOPIC  
ALUMINIUM  
3 PCS  
3 m  
THICK NET

ALUMINIUM



CARP BAJIO - 90  
CODE: 12.30.006

90x90  
CARBON

TELESCOPIC POLE  
2x1,00m



0452002  
CODE: 12.30.005

Ø 45









TELESCOPIC POLE  
2x80 cm





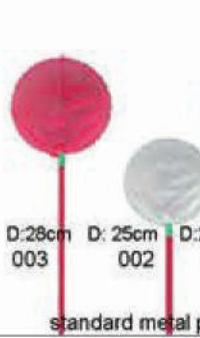

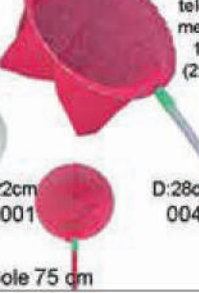

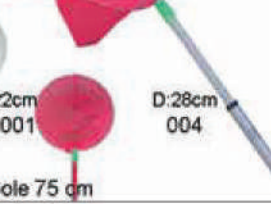

6050202  
CODE: 12.30.004



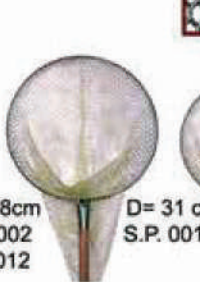

60x60  
ALUMINIUM

TELESCOPIC POLE  
2x1,00m

<p><b>CLASSIC TYPE - STEEL FRAME - " CT series "</b>          Set with WOODEN POLE 90cm or          TELESCOPIC METAL POLE 200cm (2x100)   MESH SIZE 10mm</p>					<p><b>" KIDS series "</b></p>			
								
D= 49 cm S.P. 004 T.P. 014	D= 49 cm S.P. 003 T.P. 013	D= 38cm S.P. 002 T.P. 012	D= 31 cm S.P. 001	D= 29 cm S.P. 000	D:28cm 003	D: 25cm 002	D:22cm 001	D:28cm 004
S.P. =Standard wooden pole 90cm T.P. =telescopic metal pole 200cm <b>Code: 12.26.***</b>					telescopic metal pole 160cm (2x80cm) standard metal pole 75 cm <b>Code: 12.35.***</b>			

Telescopic poles "2x100 cm", means that the pole is collapsible and we can fix it in any length till to 200cm.

<p><b>AQUACULTURE NET - STEEL FRAME - " ASL series "</b>          Set with WOODEN POLE 90cm or          TELESCOPIC METAL POLE 200cm (2x100)</p>					
<p> EXTRA STRONG NET          MESH SIZE 10mm</p>					
					
					
D= 49 cm S.P. 004 T.P. 014		D= 49 cm S.P. 003 T.P. 013		D= 38cm S.P. 002 T.P. 012	
					
D= 31 cm S.P. 001		D= 29 cm S.P. 000		D= 29 cm S.P. 000	
S.P. = Standard wooden pole 90cm T.P. = telescopic metal pole 200cm <b>Code: 12.98.***</b>					

<p><b>ALUMINIUM FRAME - " AF series "</b>          Set with WOODEN POLE 90cm or          TELESCOPIC METAL POLE 200cm (2x100)</p>		
 PETH NET 8 mm		
		
D= 42 cm S.P. 000 T.P. 010	D= 42 cm S.P. 000 T.P. 010	44X48 cm S.P. 001 T.P. 011
S.P. = Standard wooden pole 90cm T.P. = Telescopic metal pole 200cm <b>Code: 12.74.***</b>		

<p><b>ALUMINIUM FRAME - " AFM series "</b>          Set with WOODEN POLE 90cm or          TELESCOPIC METAL POLE 200cm (2x100)</p>	
<p>extra strong monofilament net 0,60 mm   mesh size 32 mm</p>	
	
D= 48 cm S.P. 000 T.P. 010	44X48 cm S.P. 001 T.P. 011
S.P. = Standard wooden pole 90cm T.P. = Telescopic metal pole 200cm <b>Code: 12.75.***</b>	

<p><b>COLLAPSIBLE STAINLESS STEEL FRAMES - " CSL series "</b>          HEAVY DUTY - BEST CHOICE FOR MOST OF TECHNICS          Set with high quality standard or telescopic aluminium poles</p>	
<p>extra strong monofilament net 0,60 mm   mesh size 32 mm</p>	
	
net is fitted on frame with "match" technic	60x60 cm S.P. : 12.76.*** T.P. : 12.77.***
<p>"Match" characterizes the net movement on frame. Until fish press on net, it seems like not having any depth, so it's invisible and doesn't make them nervous.          The net "feels" the pressure and hangs them with safety! Total depth of net is 75cm.</p>	

High strength collapsible inox frames unbreakable (tied with PETH rope).  
 High quality glass fiber reinforced polyamid base-connector with inox screws & spring.  
*Aluminium is specifically processed and doesn't worn out by marine water or hard use.*

Standard pole length:  
 15 - 60 - 80 - 100 - 125 - 150 cm  
**code: 12.76.\*\*\***

Telescopic pole length:  
 2x60 - 2x80 - 2x100 - 2x125 - 2x150 - 3x100 - 3x150 cm  
**code: 12.77.001 - 002 - 003 - 004 - 005 - 006 - 007**



**SPEARGUN WINNER**

stainless steel shaft 7mm screw - black latex bands D16 - aluminium tube D28 - cassette trigger mechanism  
spear tip 13.64.001 - spring slide ring - spring wishbone - polyester rope 1,8mm - stainless steel screws

LENGTH: 30, 45, 60, 75, 82, 90cm      CODE: 25.00.\*\*\*      **CLASSIC**



**SPEARGUN WINNER TAHITIEN**

stainless steel tahitian shaft 6,35 - black/amber latex bands D17,5 - aluminium tube D28 - cassette trigger mechanism  
articulated inox wishbone - monofilament 1,5mm + double clip - stainless steel screws

LENGTH: 60, 75, 82, 90cm      CODE: 25.01.\*\*\*      **SPORTLINE**



**SPEARGUN'S FULL STOCK SPARE PARTS**

001 002 003 004 005 006 007 008 009 010 011 012 013

CODE: 25.02.\*\*\*

**SPEARGUN INOX SHAFTS**

shaft thickness 7 mm - code: 25.03.\*\*\*

all shafts  
screwing M7/100

shaft thickness 6,35 mm - code:25.04.\*\*\*

LENGTH: 60, 75, 90, 98, 105, 115, 130  
CODE: 25.03.\*\*\*

LENGTH: 45, 60, 75, 90, 105, 115,  
125,130  
CODE: 25.04.\*\*\*

**TAHITIAN INOX SHAFTS**

shaft thickness 6,35 mm - code: 25.05.\*\*\*

LENGTH: 45, 60, 75, 90, 105, 115,  
125,130  
CODE: 25.05.\*\*\*



INOX  
CODE: 25.06.000

INOX  
25.07.002

INOX  
25.07.001

INOX  
25.08.001

INOX  
25.08.002

INOX  
25.09.001

ALUMINIUM  
25.09.002

WAW-L  
CODE: 25.08.003

WAWI-L  
CODE: 25.08.004

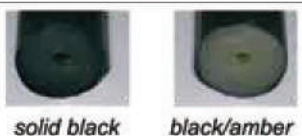

solid black      black/amber

**LATEX BANDS**

Top quality latex made in USA  
Extra strong , high elasticity (over 750%).  
Memory is maintained even after repeated stretching.  
Great smoothness - high gripping power.

D16 – solid black bands

LENGTH:2pcs/bag: 10-12-14-16-18-  
20-22-24-26-28-30  
1pcs/bag:38-42-48-54-60-65  
CODE: 25.10.\*\*\*

D16 - black/amber bands

LENGTH: 2pcs/bag: 10-12-14-16-18-  
20-22-24-26-28-30  
1pcs/bag:38-42-48-54-60-65  
CODE: 25.11.\*\*\*

D17,5 - black/amber bands

LENGTH: 2pcs/bag: 10-12-14-16-18-  
20-22-24-26-28-30  
1pcs/bag:38-42-48-54-60-65  
CODE: 25.12.\*\*\*



**BULK LATEX TUBES**

TYPE: SOLID AMBER 8mm      CODE: 25.13.008  
TYPE: SOLID BLACK 14,5mm      CODE: 25.14.145  
TYPE: SOLID BLACK 16mm      CODE: 25.14.160  
TYPE: BLACK/AMBER 16mm      CODE: 25.15.160  
TYPE: BLACK/AMBER 17,5mm      CODE: 25.15.175



**All tridents and multiprongs screwing 7/100mm**



**STAINLESS STEEL FISH STRINGER WITH LINE 150 mm**

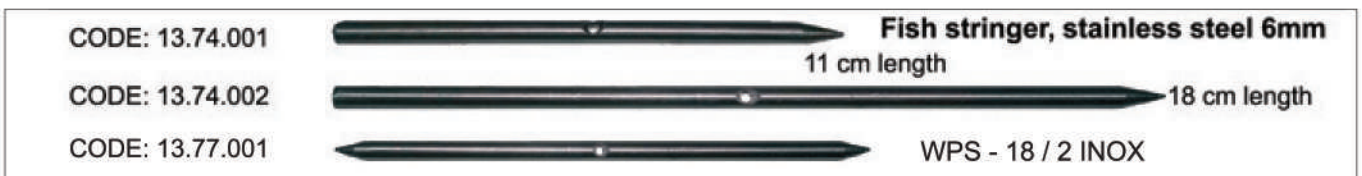

**All spear tips, tridents & multiprongs screws 7/100mm**

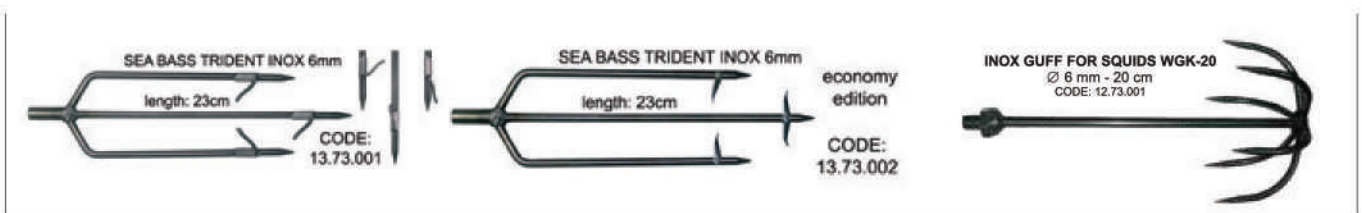
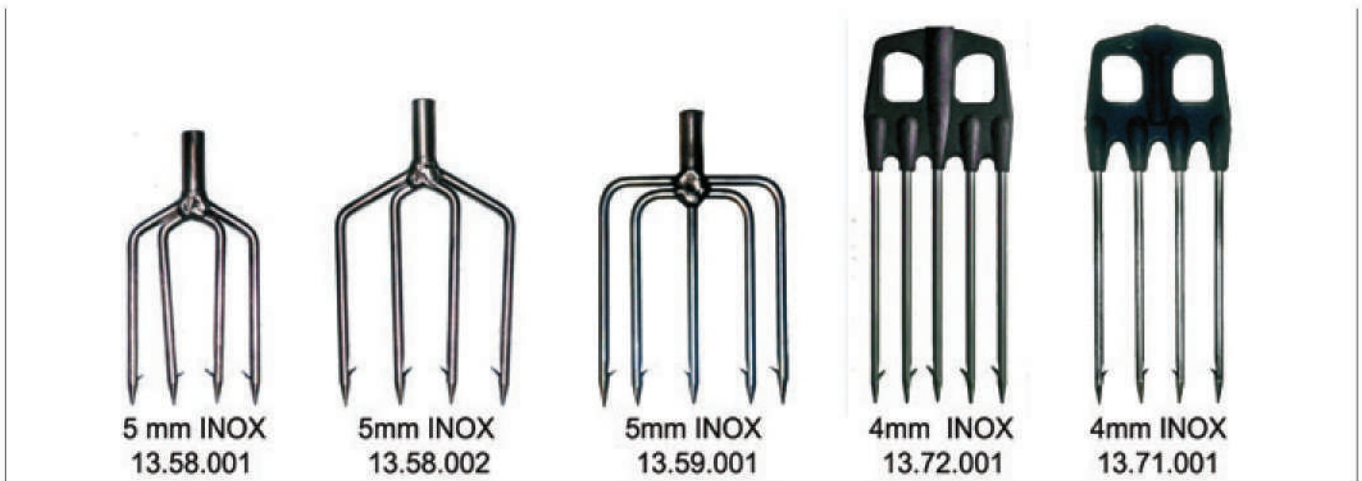
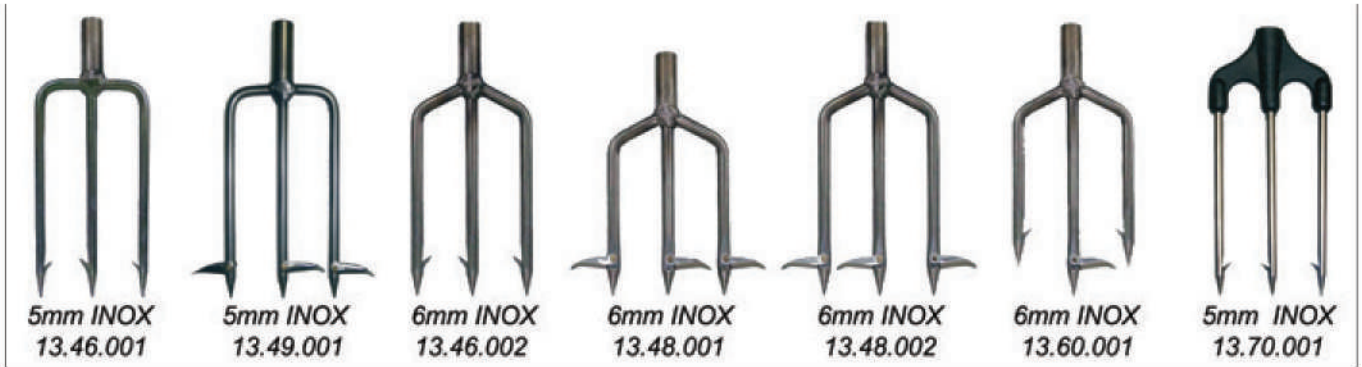
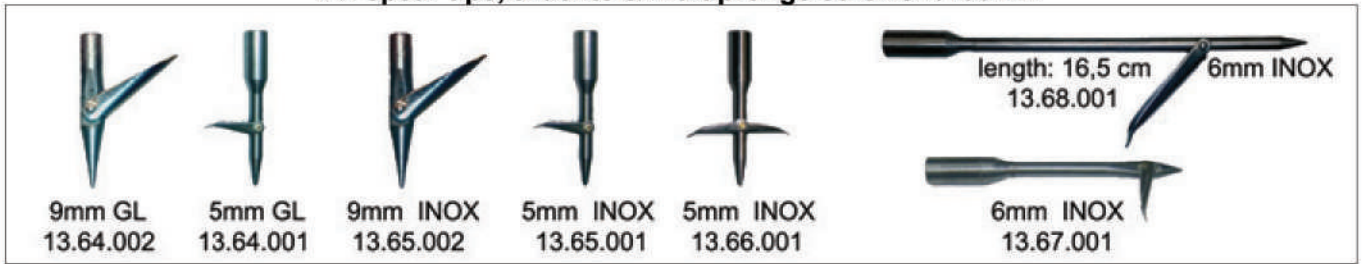



stainless steel guff set with aluminium pole



Aluminium poles are specifically processed and doesn't worn out by marine water or hard use.  
When we read for example "2x80cm", it means that the pole is collapsible and we can fix it in any length till to 160cm

<p><b>Inox guff G1</b> (6mm thickness) standard length: 40 – 60 – 80 – 100 – 125 - 150 cm code: 12.31.*** collapsible length: 2x40 - 2x60 - 2x80 - 2x100 - 2x125 2x150 – 3x100 – 3x150 cm code: 12.32.001 – 002 – 003 – 004 – 005 006 - 007 - 008</p>	<p><b>Inox guff G2</b> (8mm thickness) standard length: 40 – 60 – 80 – 100 – 125 - 150 cm code: 12.70.*** collapsible length: 2x40 - 2x60 - 2x80 - 2x100 - 2x125 2x150 – 3x100 – 3x150 cm code: 12.71.001 – 002 – 003 – 004 – 005 006 – 007 - 008</p>
---	---

<p>stainless steel guff 6mm thickness</p> <p>Code: 12.72.001</p>	<p>stainless steel guff 6mm thickness</p> <p>Code: 12.72.002</p>	<p>stainless steel guff 5mm thickness</p> <p>Code: 12.72.003</p>	<p>stainless steel electrowelded screw M10</p> <p>Code: 12.72.004</p>
--	--	--	---

<p><b>aluminium screwing poles M10</b></p> <p>Aluminium poles are specifically processed and doesn't worn out by marine water or hard use. When we read for example "2x80cm", it means that the pole is collapsible and we can fix it in any length till to 160cm</p>	
<p>standard length: 40 – 60 – 80 – 100 – 125 - 150 cm code: 12.27.***</p>	<p>collapsible length: 2x40 - 2x60 - 2x80 - 2x100 - 2x125 2x150 – 3x100 – 3x150 cm code: 12.28.001 - 002 – 003 - 004 - 005 - 006 - 007 - 008</p>

<p><b>Harpoon 4mm thickness</b></p> <p>Code: 13.31.***</p>	<p><b>Harpoon 6mm thickness</b></p> <p>Code: 13.30.***</p>
--	--

<p><b>Harpoon 4mm with collapsible pole 2x80 cm</b></p> <p>3 points, 4 points, 5 points Code: 13.43.***</p>	<p><b>Harpoon 6mm with collapsible pole 2x100 &amp; 2x150 cm</b></p> <p>3-2x100( 001 ), 4-2x100 ( 002 ), 5-2x100 ( 003 ) 3-2x150 ( 004), 4-2x150 ( 005 ), 5-2x150 ( 006 ) Code: 13.44.***</p>
---	---

<p><b>TOOL FOR MUSSELS - SHELLS</b></p> <p>Code: 13.33.001</p>	<p><b>TOOL FOR MUSSELS - SHELLS</b></p> <p>Code: 13.33.***</p> <p>4 points 5 points 6 points 8 points</p>
--	---



### HEAVY DUTY SPEARGUN REEL

vertical type stainless steel body,  
top quality-durability plastic parts,



**WM 60**  
**code: 25.23.001**

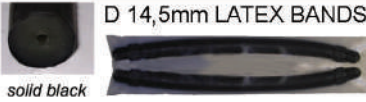

**D 14,5mm LATEX BANDS**

*solid black*

Top quality latex made in USA  
Extra strong , high elasticity (over 750%)  
Memory is maintained even after repeated stretching.  
Great smoothness - high gripping power.

LENGTH:  
2pcs/bag:10-12-14-16-18-20  
22-24-26-28-30

1pcs/bag:38-42-48-54-60-65

**CODE: 25.21.\*\*\***

REEL'S OR CAMERA'S  
UNIVERSAL HEAVY DUTY BASE



*flat surface base*  
39,5x30 mm



*open top end*  
for shaped barrels



*inox*

*D: 28 mm*

**WTB**  
**code: 25.24.001**

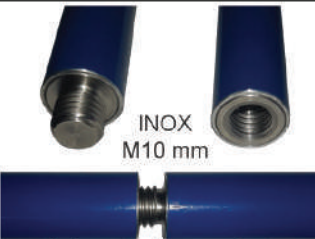

**INOX**  
**M10 mm**

stainless steel screw adapter

### EXTENDED POLE SPEAR



**8 mm**  
**solid black**  
**latex tube**

perfect match sets of 2 or 3 pieces  
D 16 aluminium watertight barrel  
easy to replace band head  
full spare parts stock

**M7/100 screwing all**  
tridents - multiprongs - spear tips

set 2 pcs	code	SET LENGTH	set 3 pcs	code
2 pcs x 50 cm	13.78.001	2x50=100 cm	3 pcs x 50 cm	13.79.001
2 pcs x 62,5 cm	13.78.002	3x50=150 cm	3 pcs x 62,5 cm	13.79.002
2 pcs x 75 cm	13.78.003	2x75=150 cm		
		2x62,5=125 cm		
		3x62,5 cm=187,5 cm		

### STAINLESS STEEL BARBS & PINS



length 60 mm  
shaft thickness 6,5 up to 7 mm

**W600**

**code: 25.16.001**



length 60 mm  
shaft thickness 6 up to 6,35 mm

**W604**

**code: 25.16.002**



length 54 mm  
shaft thickness 6 up to 6,5 mm

**W544**

**code: 25.16.003**



length 44 mm  
spear tips T9

**W440**

**code: 25.16.004**



length 24 mm  
spear tips & tridents

**W240**

**code: 25.16.005**



*heavy duty 3mm*  
*stainless steel*  
*wishbone*

**WWL**

**code: 25.19.001**

### HEAVY DUTY MUZZLE'S BUNGEE

SPEARGUN'S SHOCK CORD BUNGEE



*7 mm latex tube*  
*inox spring adapter*  
*1,7 mm dyneema cord*

*latex 15 cm to 30 cm*

**WLT-15 code: 25.25.001**

### ELASTIC BELT

50 mm x 135 cm



**code: 13.75.004**

### STAINLESS STEEL SCREWING M7/100

**PARALYZER**  
**INOX**



**4 mm**  
**WP4.2**  
**13.80.003**

**WP3.2**



**4 mm**  
**WP3.2**  
**13.80.002**

**WP3 mini**



**4 mm**  
**WP3 mini**  
**13.80.001**

**PLASTIC**  
**BASE**



**4 mm**  
**WTP3 mini**  
**13.81.001**

**PLASTIC**  
**BASE**



**4 mm**  
**WTP3.1**  
**13.81.002**

**KALYMNOS 3**



**5 mm**  
**KALYMNOS 3**  
**13.95.001**

**KALYMNOS 4**



**5 mm**  
**KALYMNOS 4**  
**13.95.002**



**6 mm**  
**SEA BASS**  
**13.73.003**



1th km. Simmachiki str.  
Diavata - Oreokastro  
P.C. 570 08 Thessaloniki  
P.O.B. 2063 - Greece

TEL: +302310510244  
+302310516433  
FAX: +302310550212

e-mail: [info@takiskalaitzis.com](mailto:info@takiskalaitzis.com)

---

[www.winnerfishingtackle.gr](http://www.winnerfishingtackle.gr)